

# Apostila com sugestões de Pioneirias escoteiras

## ÍNDICE

1 Cantos de Patrulha .....	2
2 Barracas .....	3
3 Cantos de Patrulha .....	4
4 Cantos de Patrulha .....	5
5 Barracas .....	6
6 Mesas.....	7
7 Lavatórios e porta ferramentas.....	8
8 Intendência .....	9
9 Mesas.....	10
10 Mesas e porta ferramentas .....	11
11 Chuveiros.....	12
12 Lavatórios, fossas e varais.....	13
13 Latrinas e espeques .....	14
14 Latrinas.....	15
15 Fogões.....	16
16 Para cultos .....	17
17 Para fogo de conselho.....	18
18 Portais .....	19
19 Mastros.....	20
20 Porta toalha e ferramentas.....	21
21 Pontes .....	22
22 Pontes .....	23
23 Pontes .....	24
24 Pontes .....	25
25 Pontes .....	26
26 Pontes .....	27
27 Pontes .....	28
28 Pontes .....	29
29 Teleféricos .....	30
30 Teleféricos .....	31
31 Torres .....	32
32 Torres .....	33
33 Torres .....	34
34 Ergonomia no campo .....	35

# PATRULHA TIGRE - MONITOR - LEANDRO

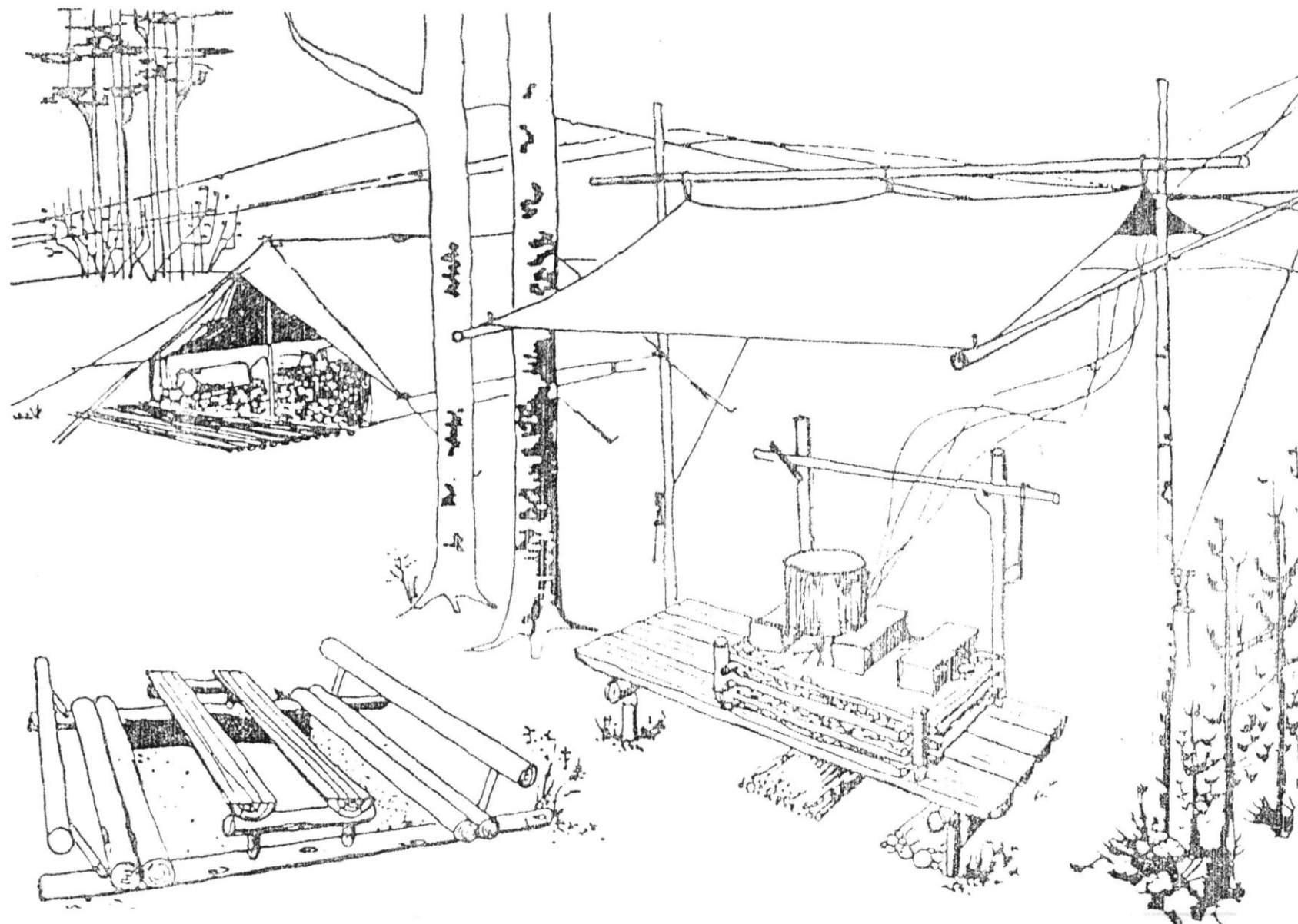

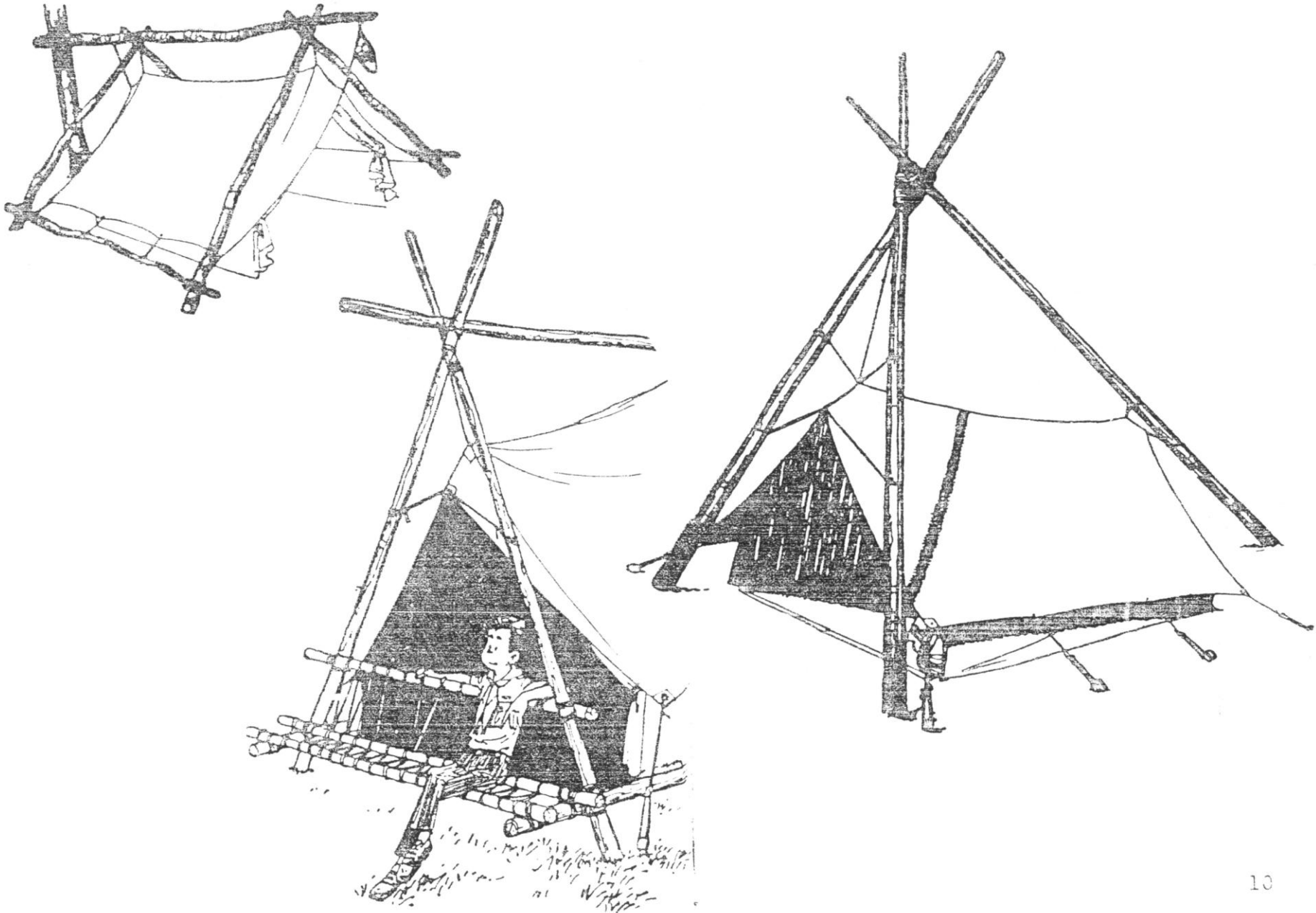

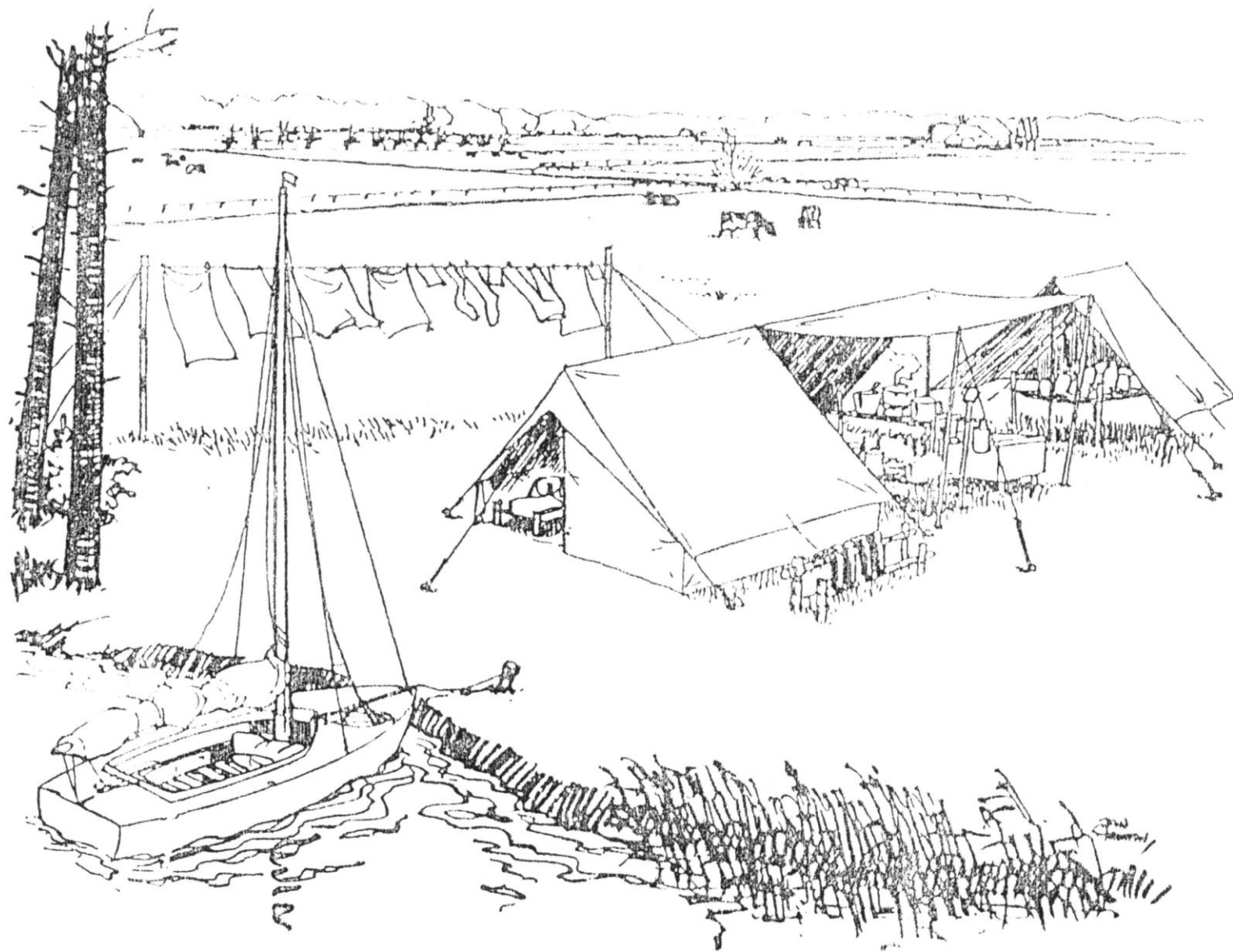



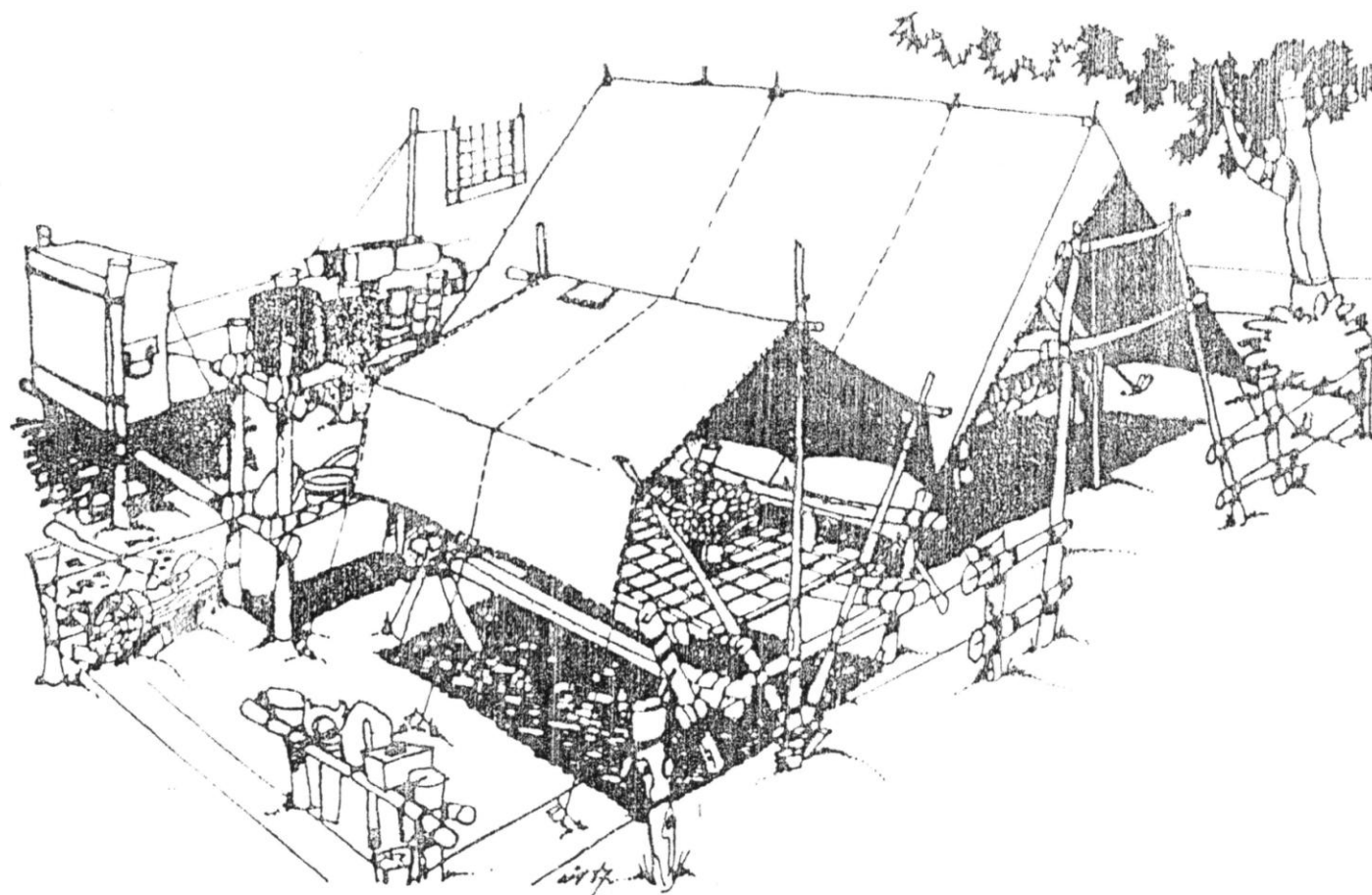

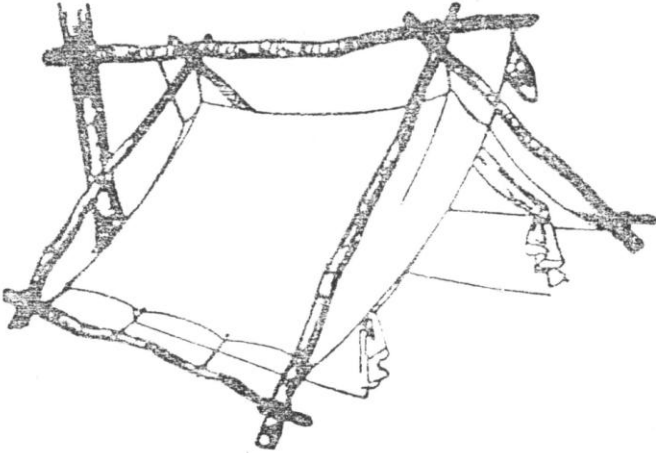
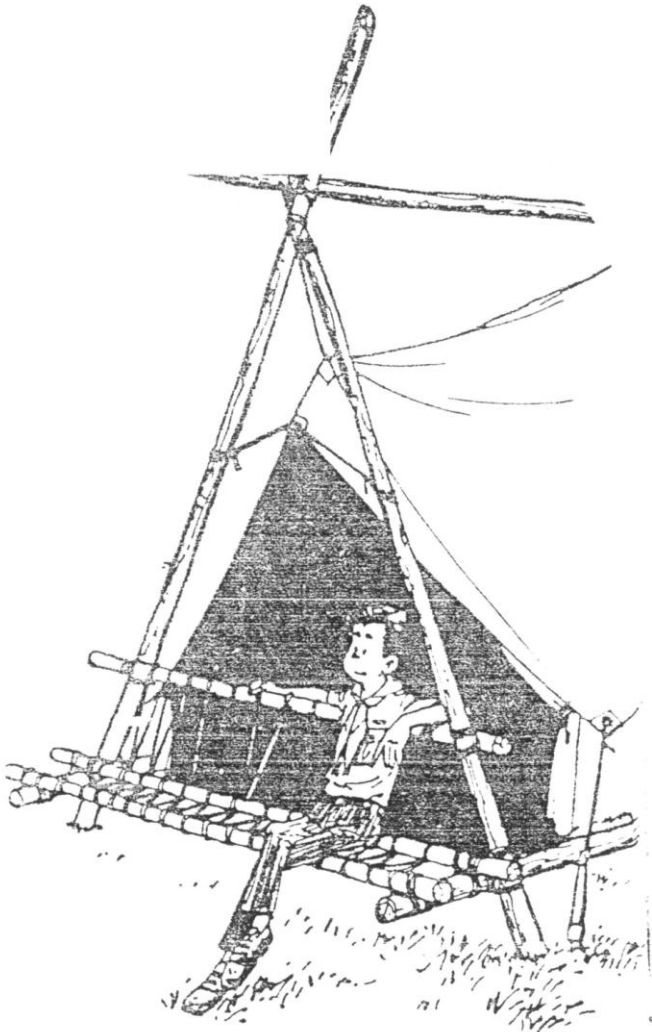

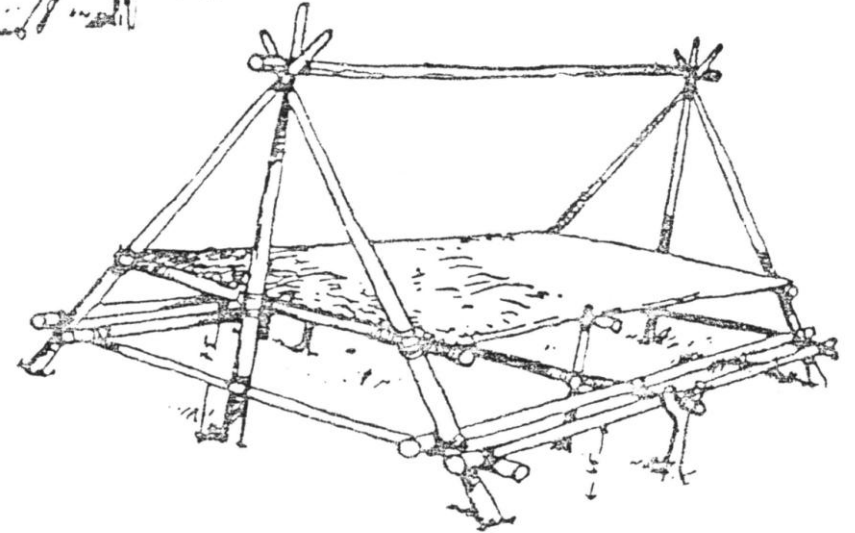
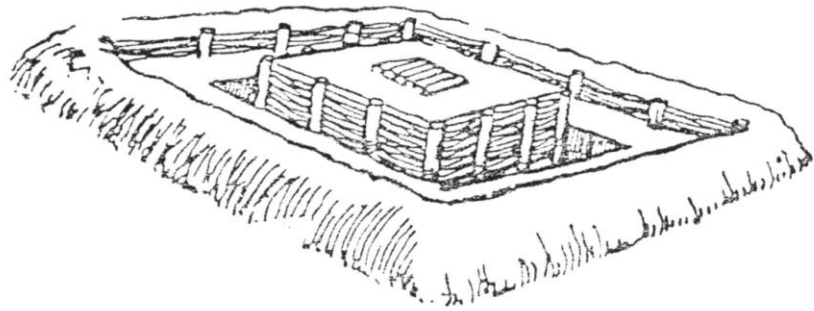
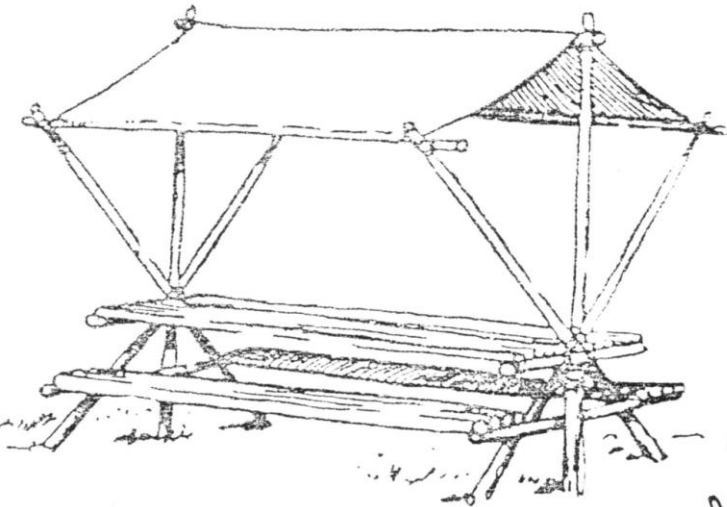
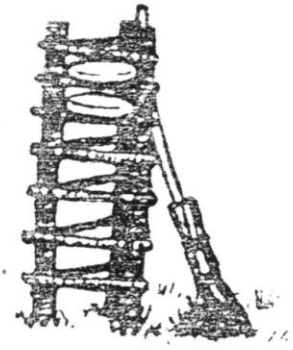
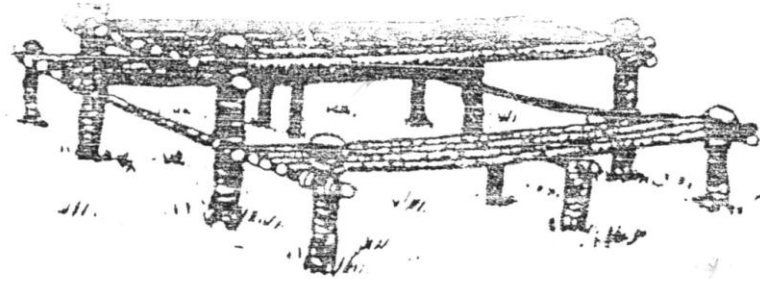
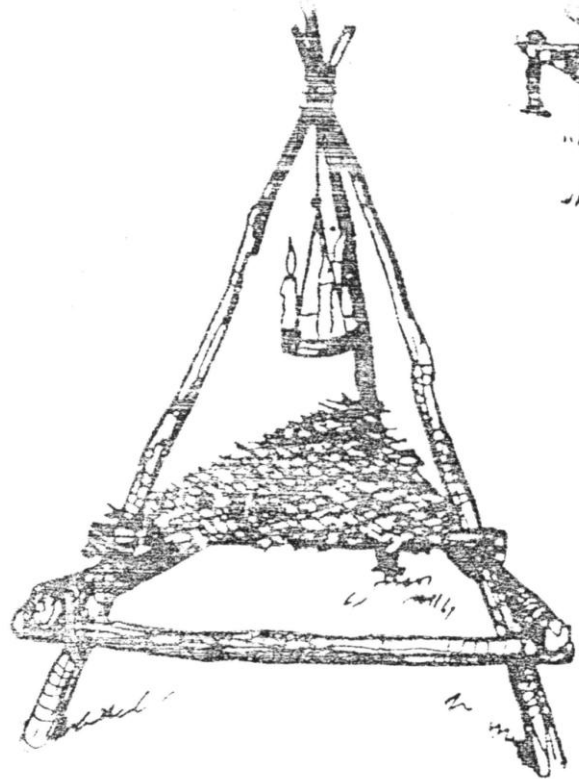



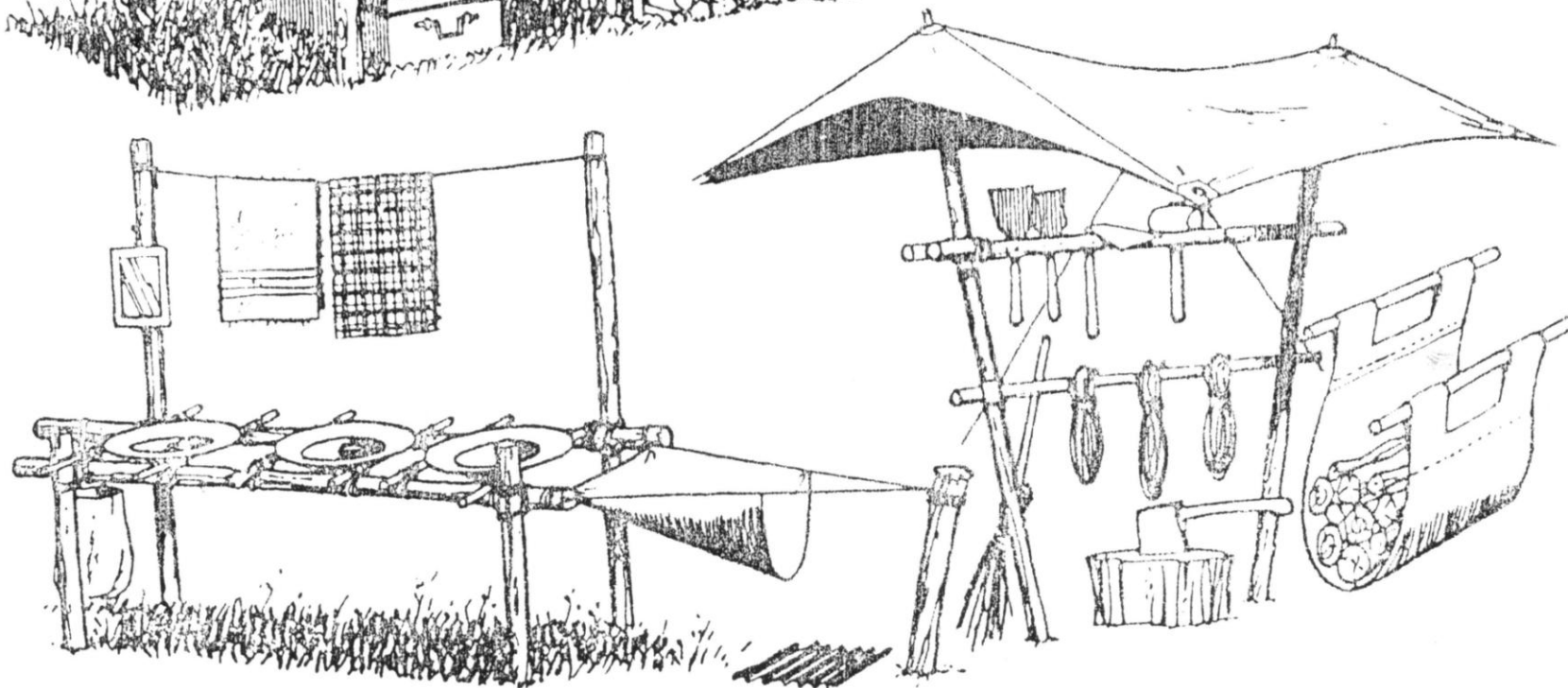
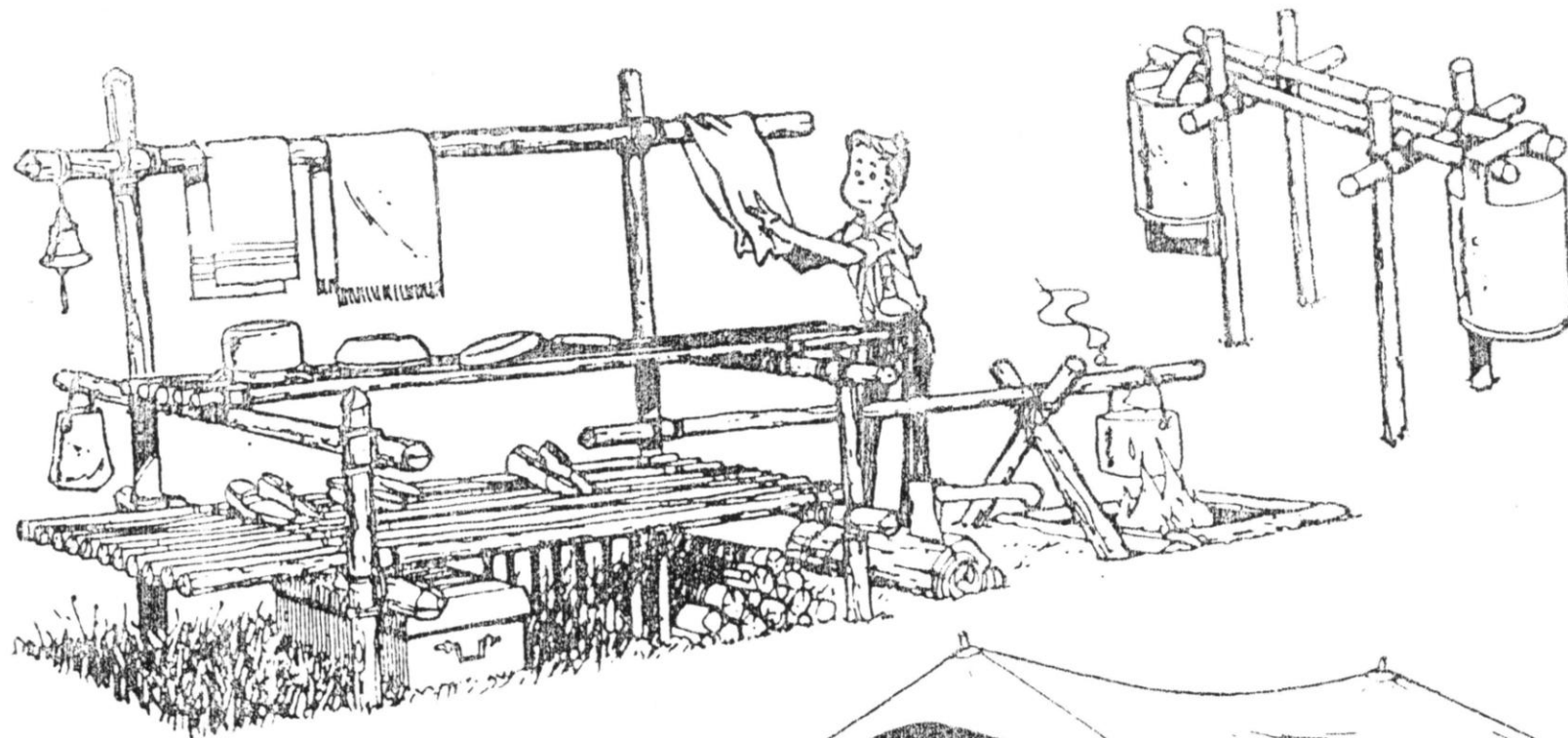



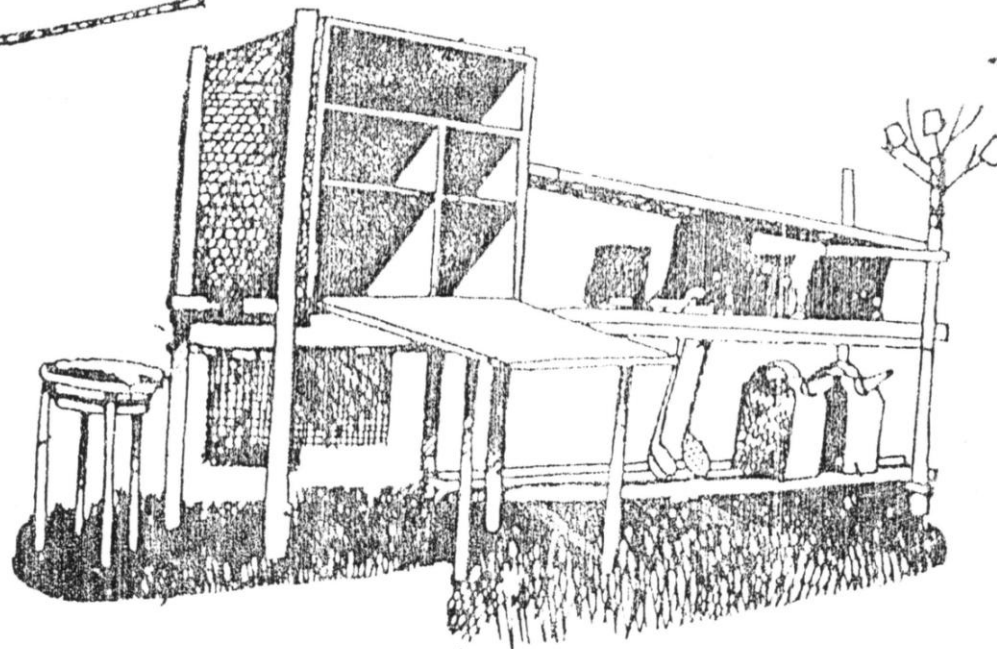
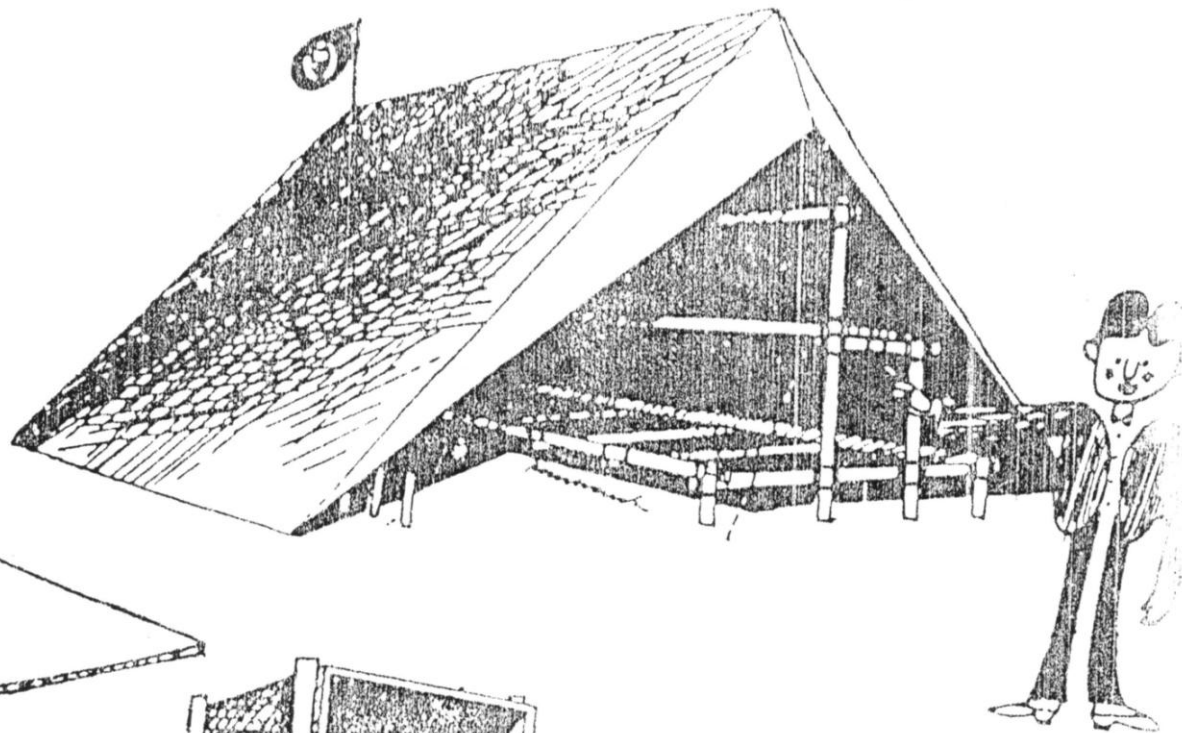
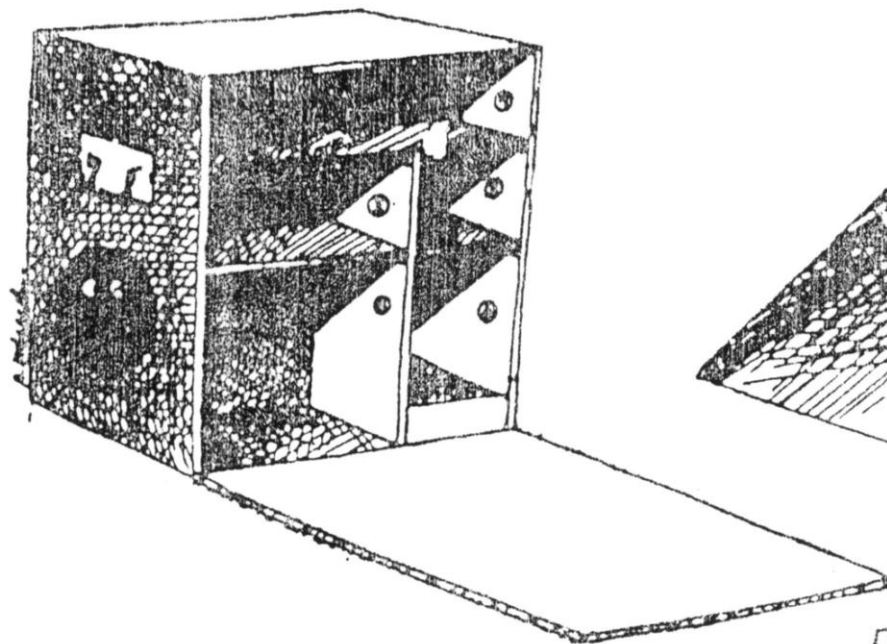

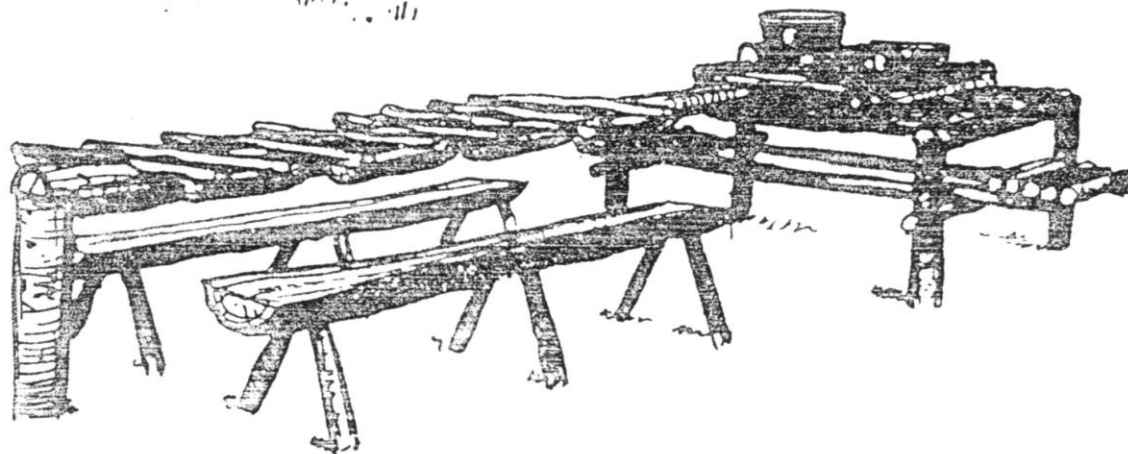
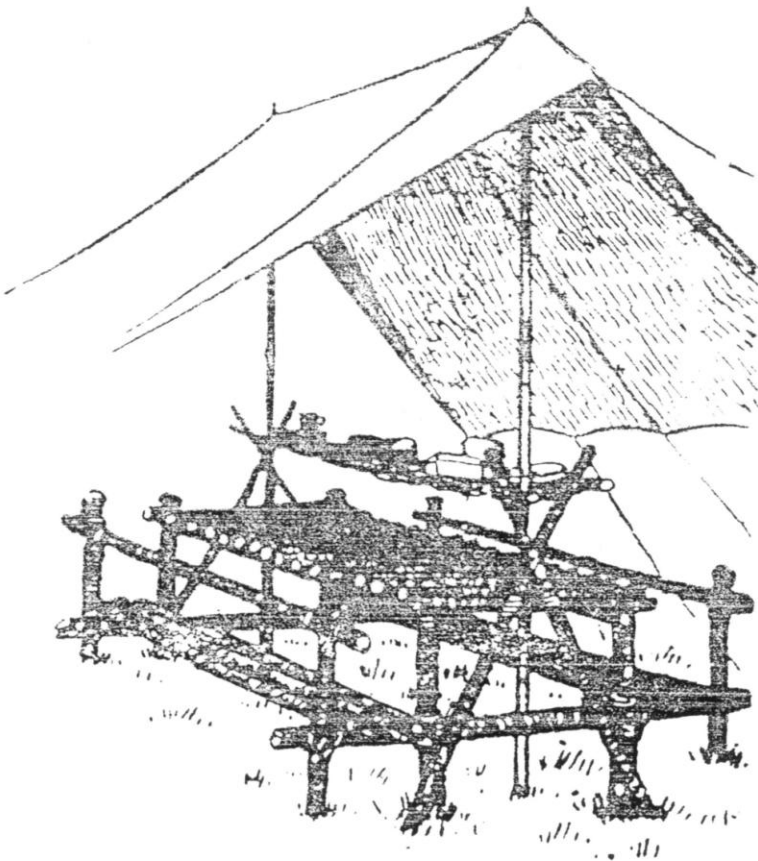



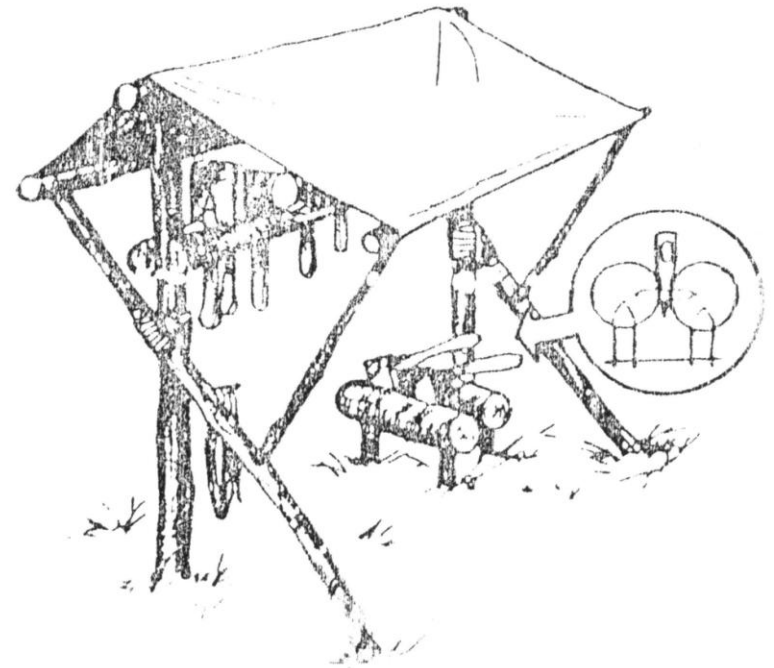
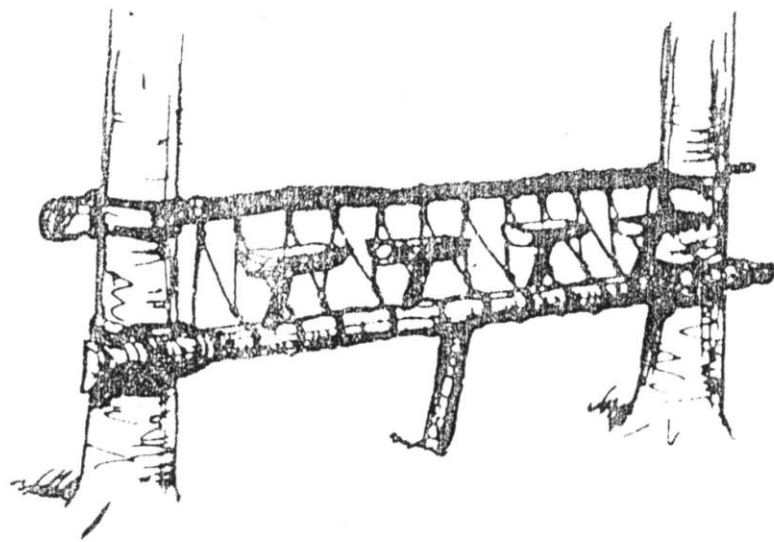
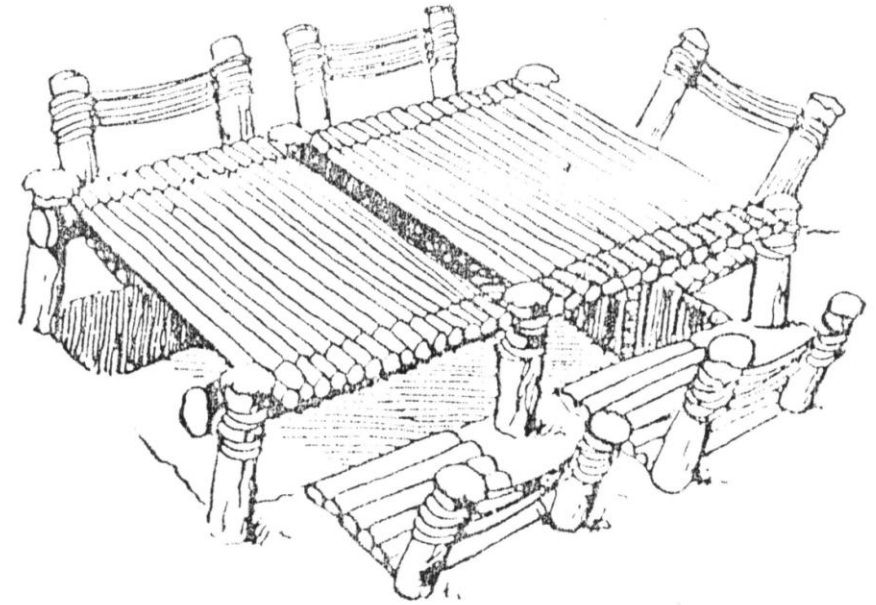
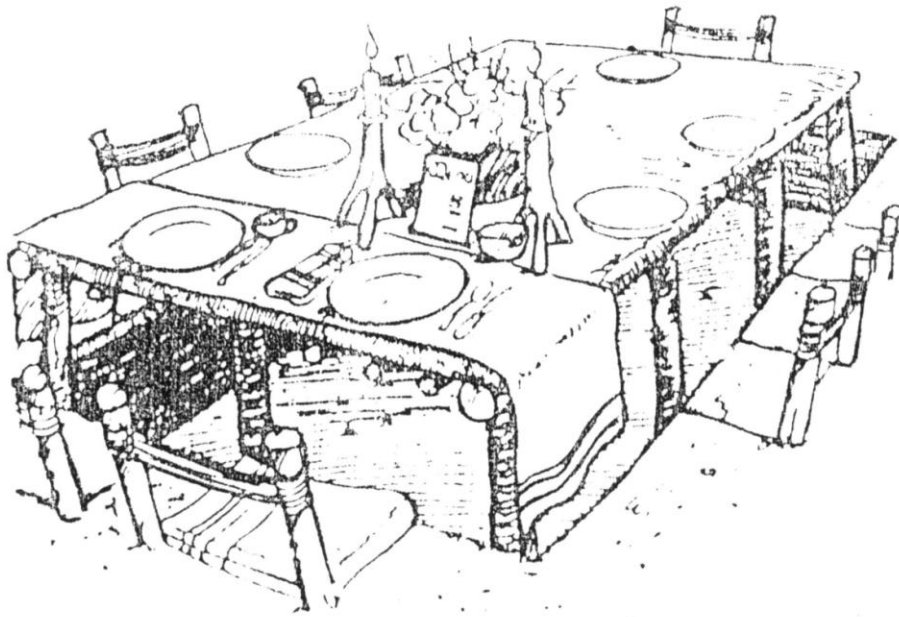



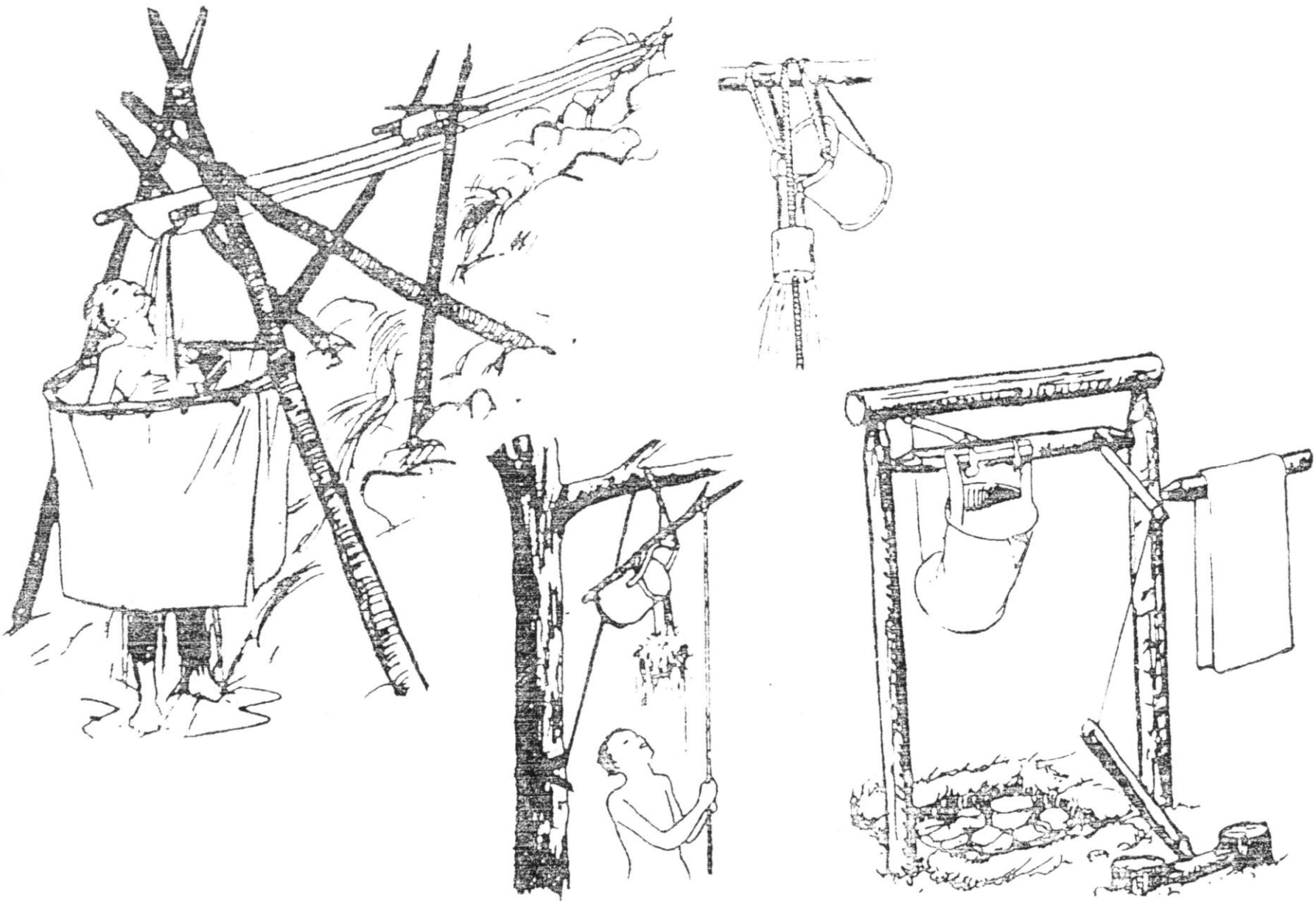

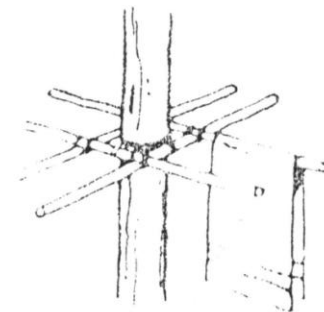
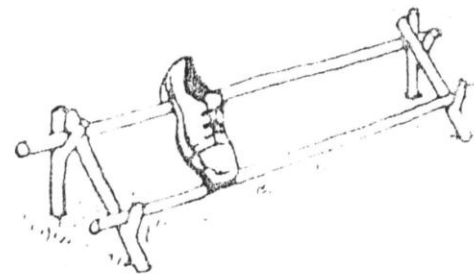
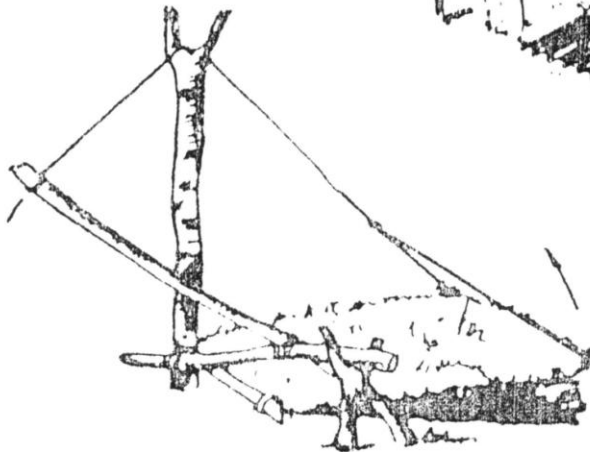
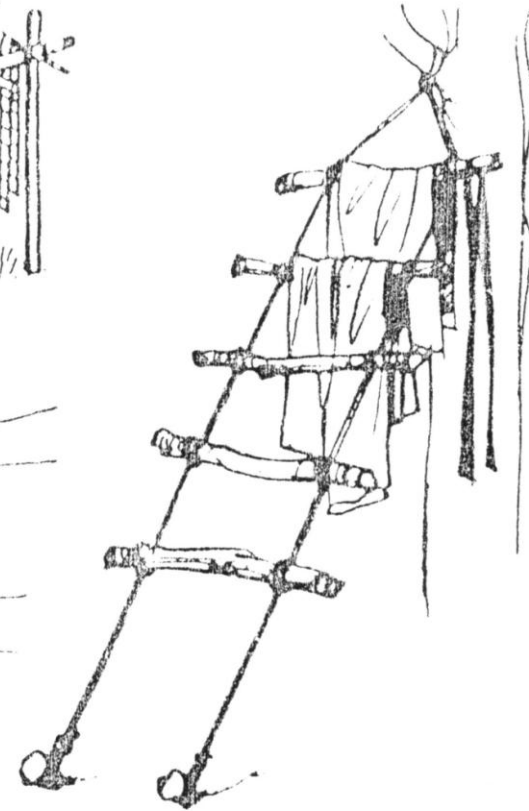
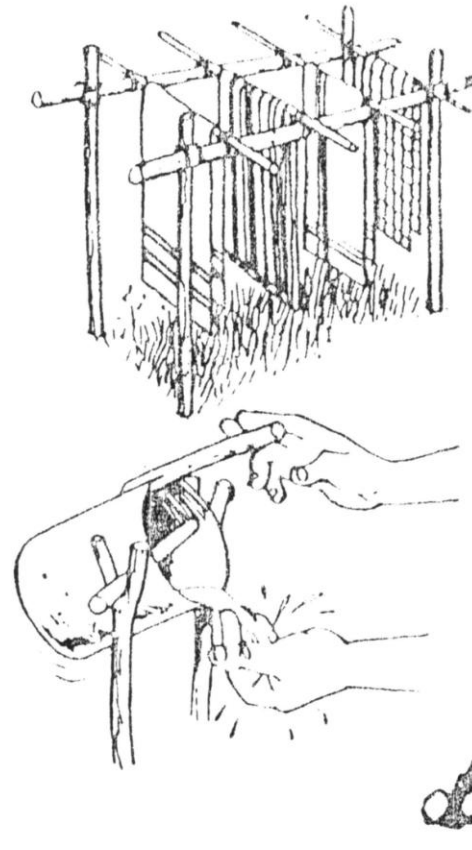
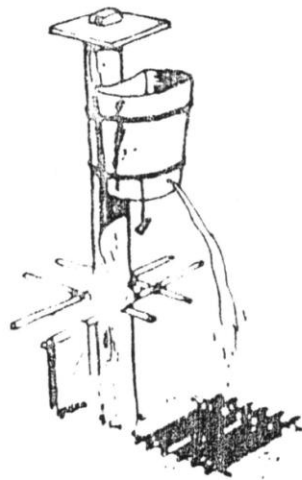
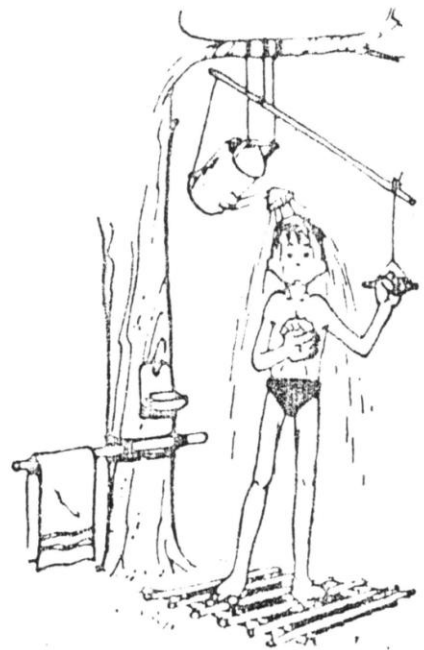

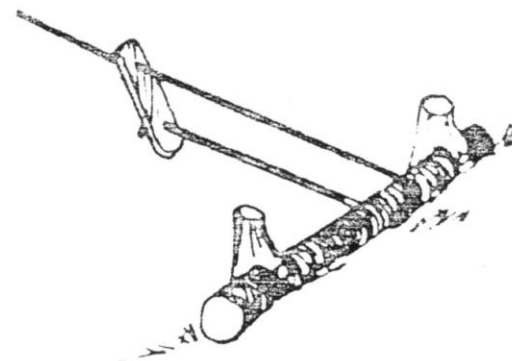
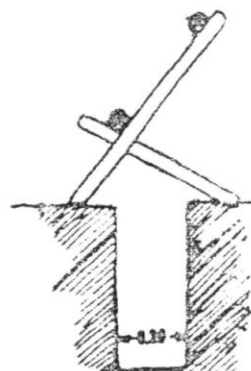
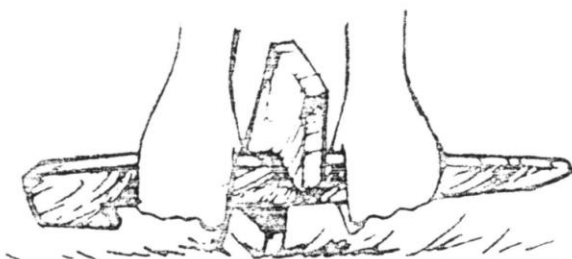
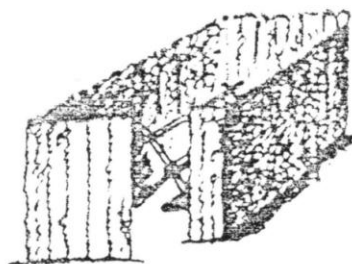
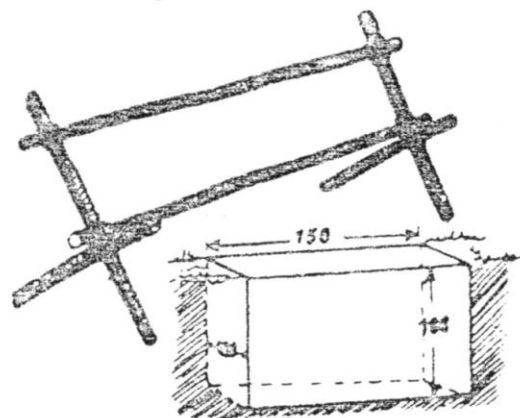
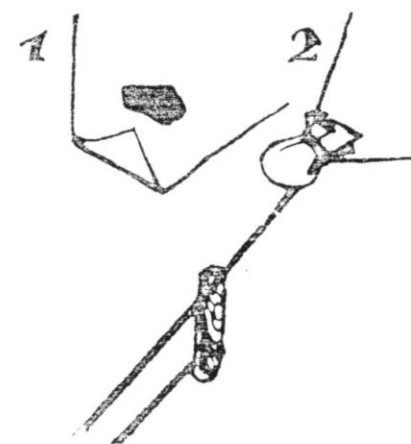
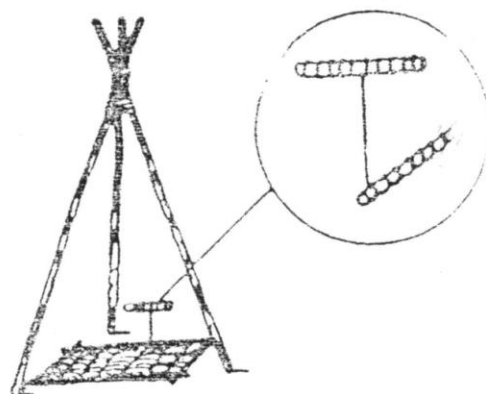
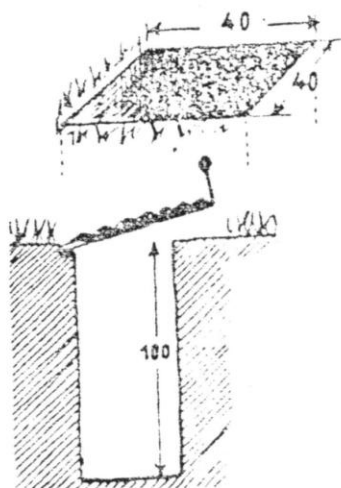



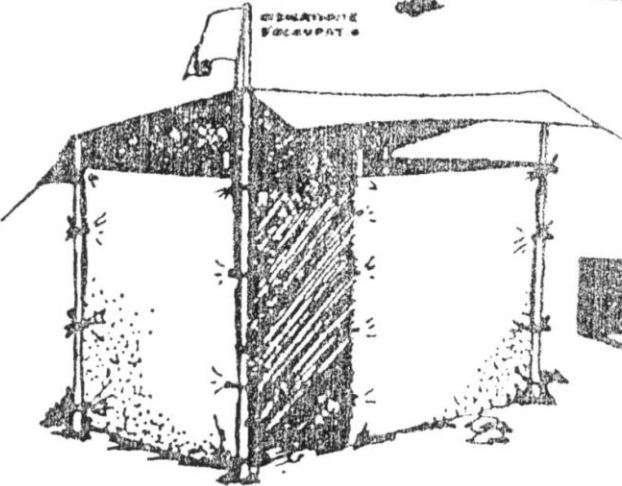
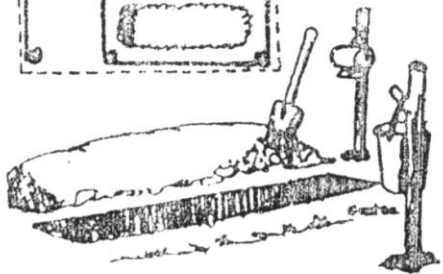
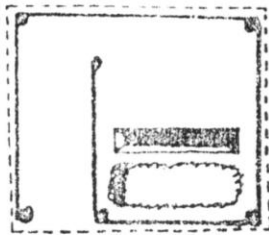
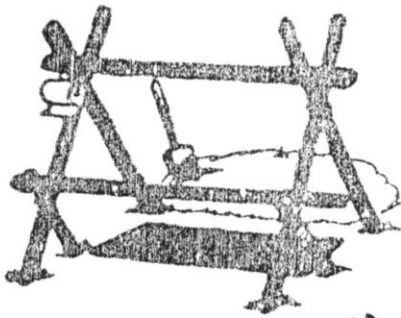
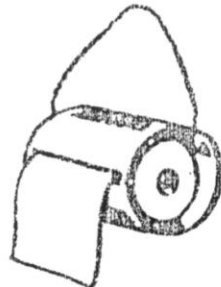
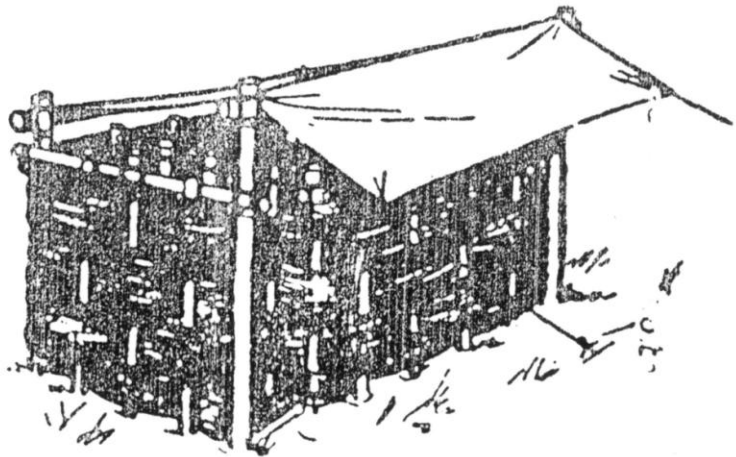

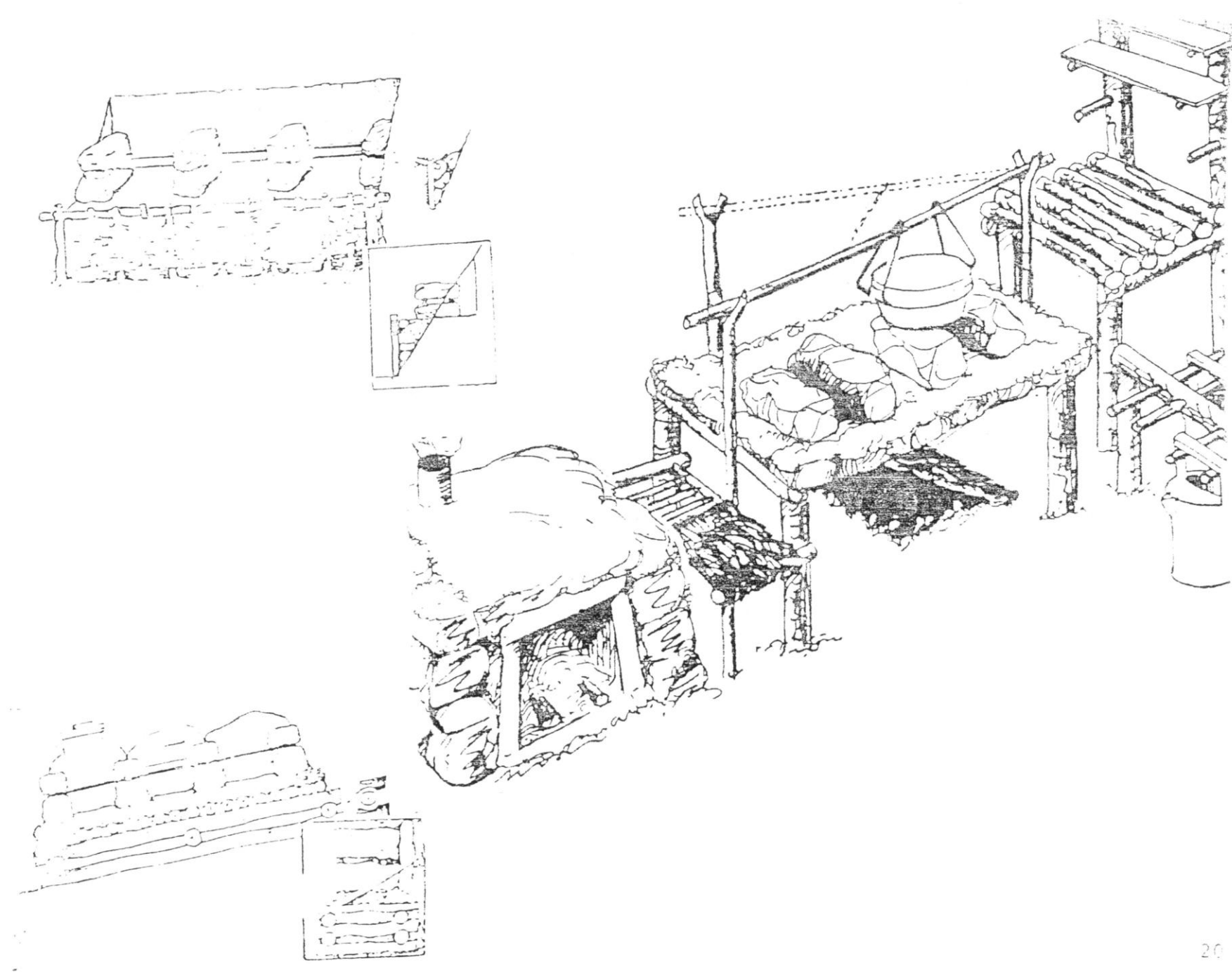

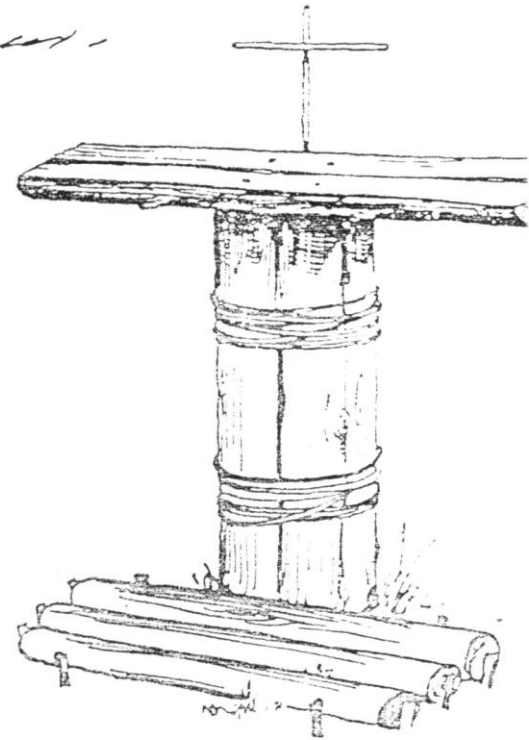
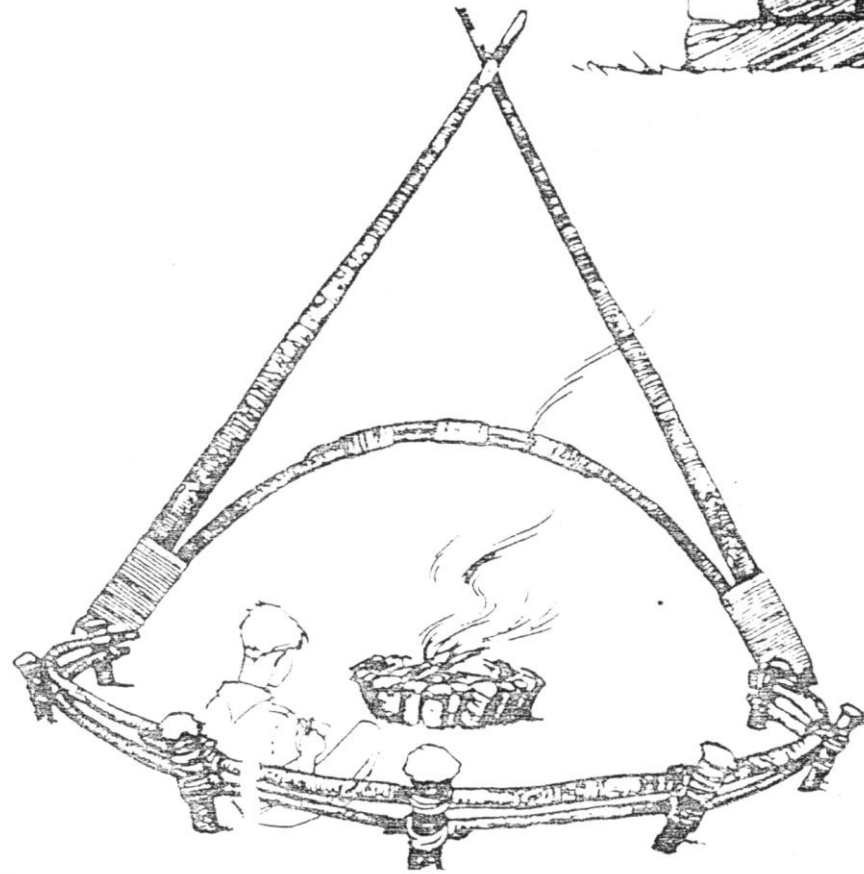
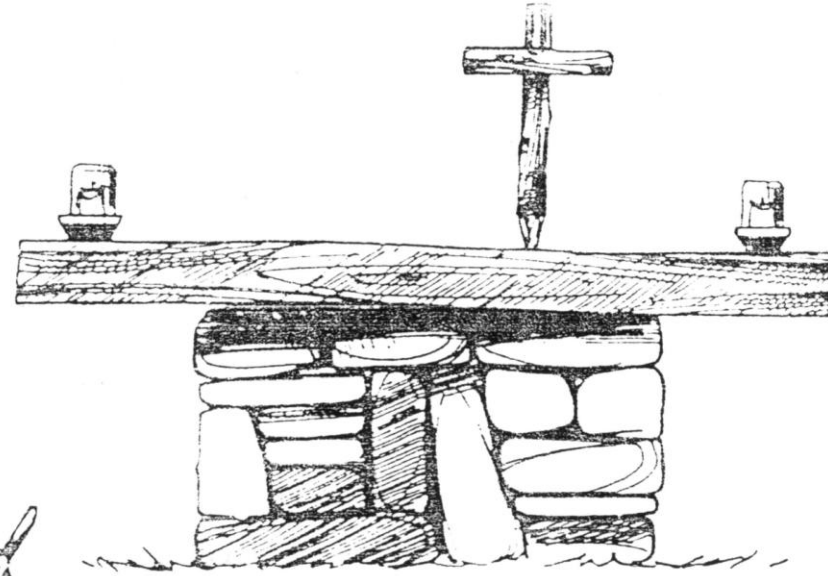



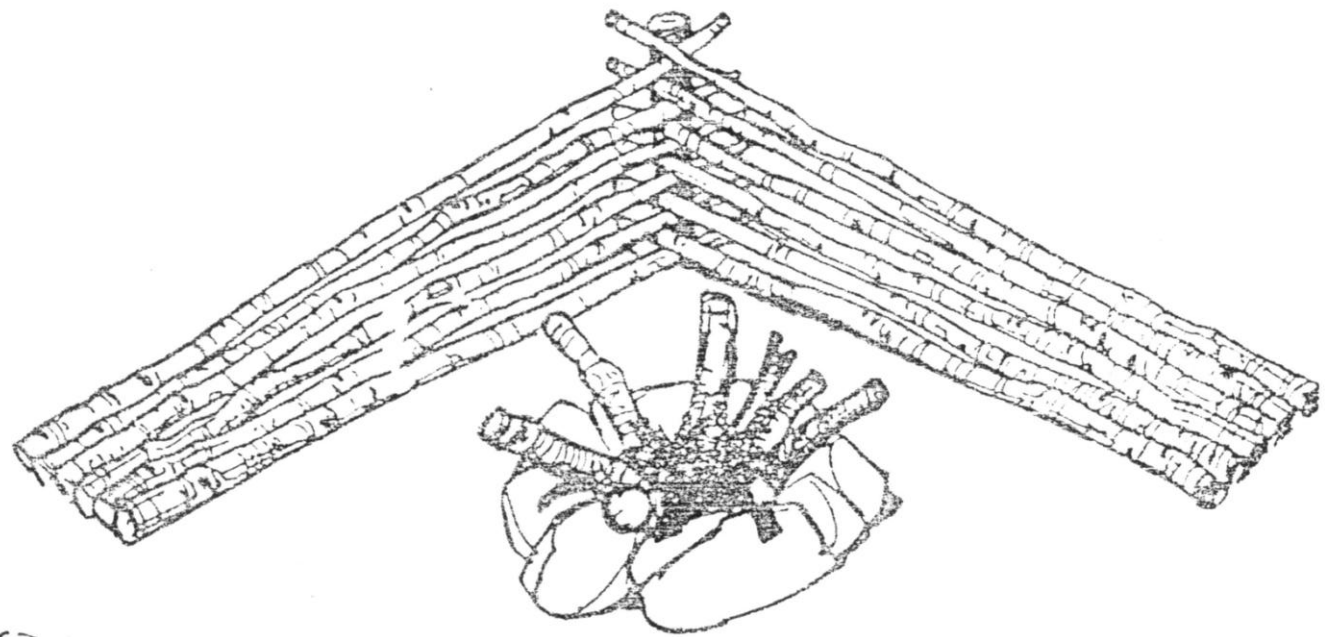

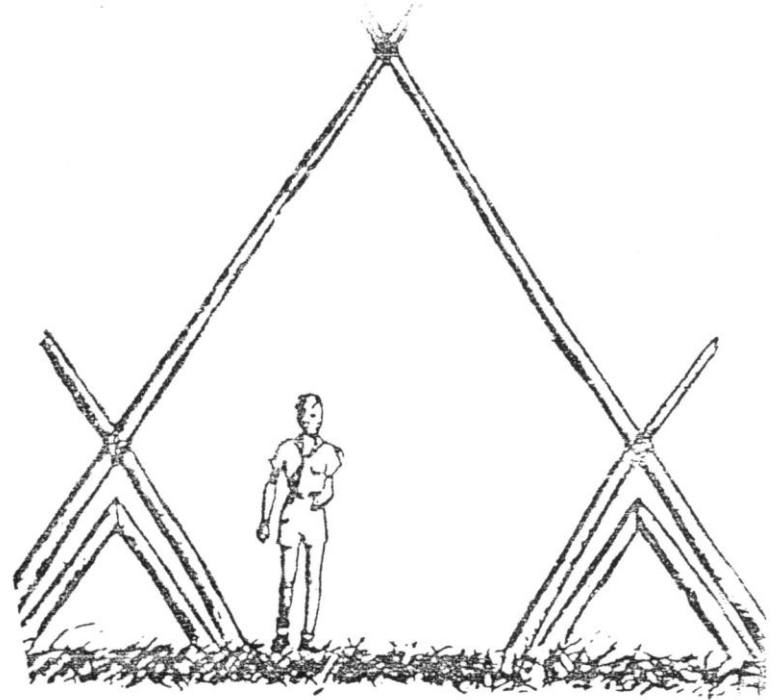
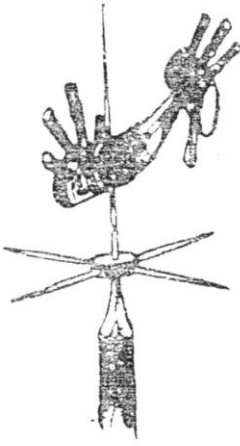
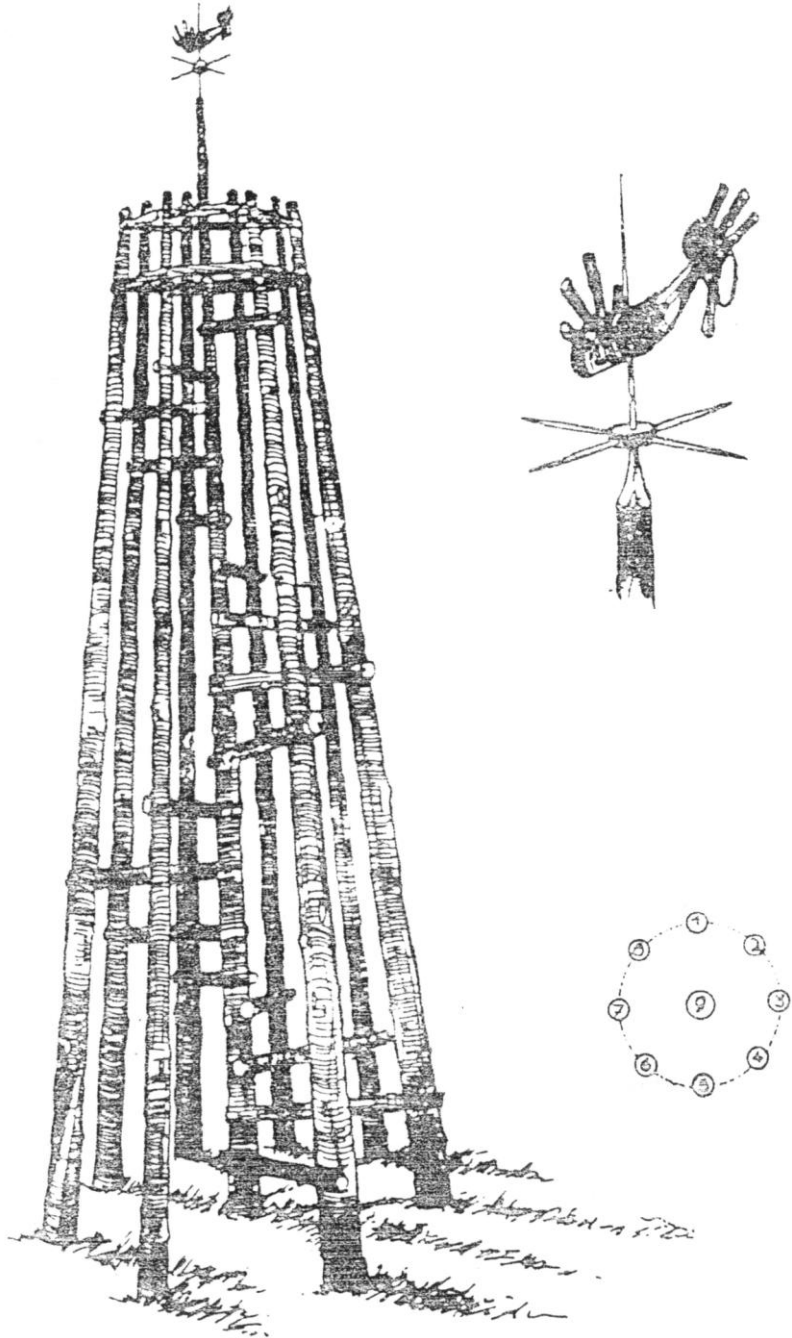

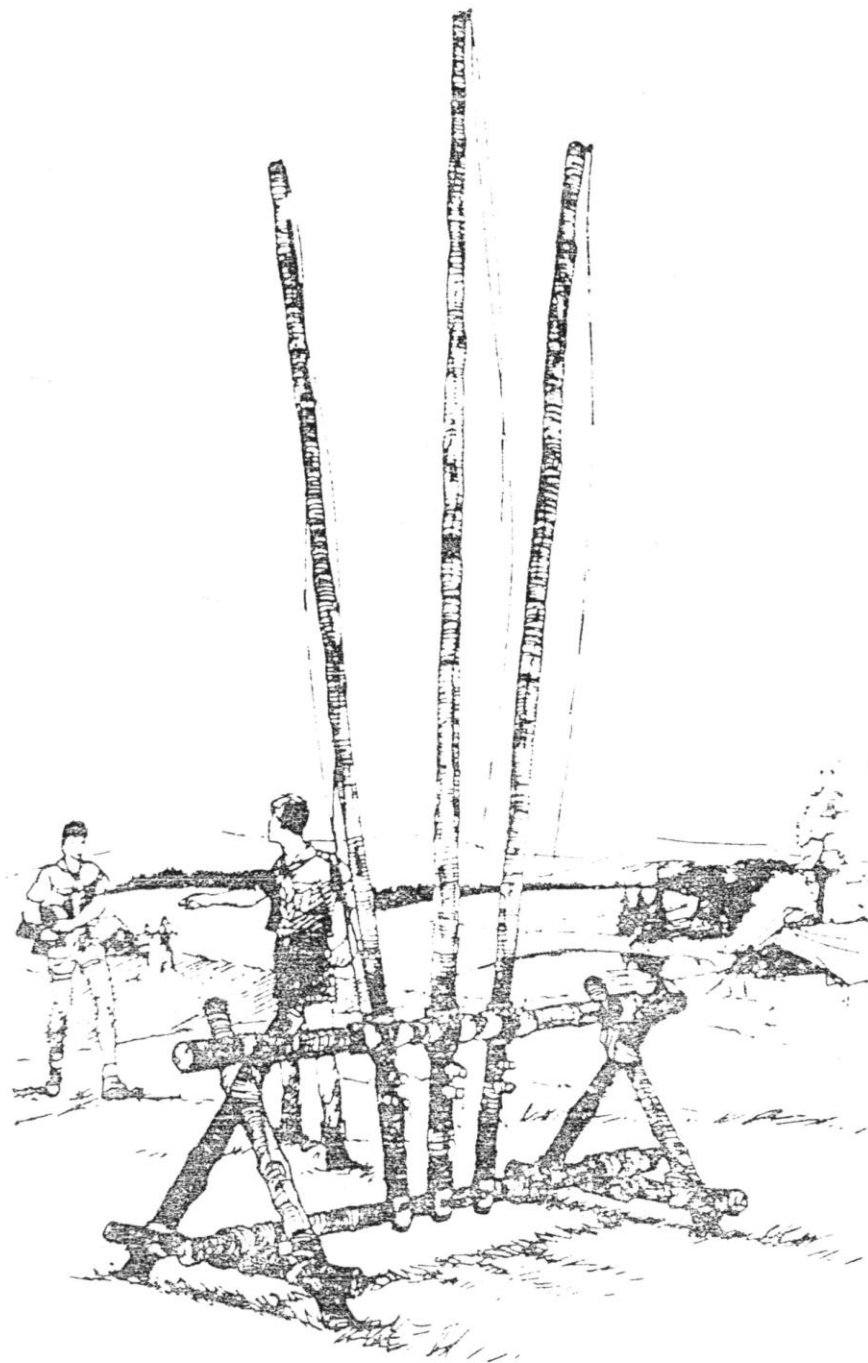



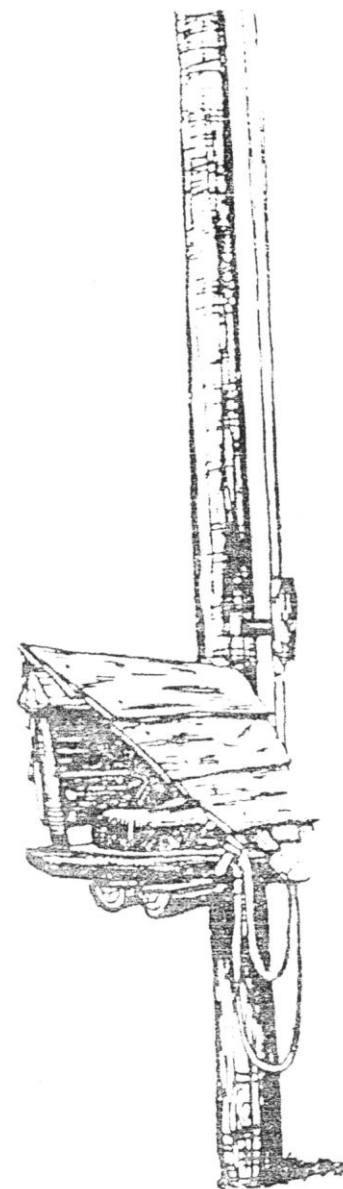
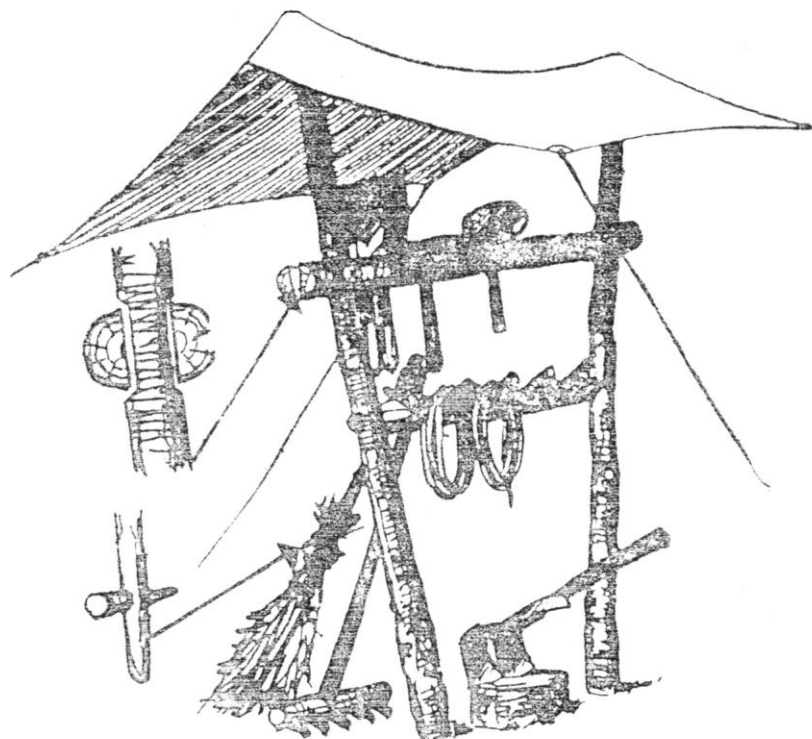
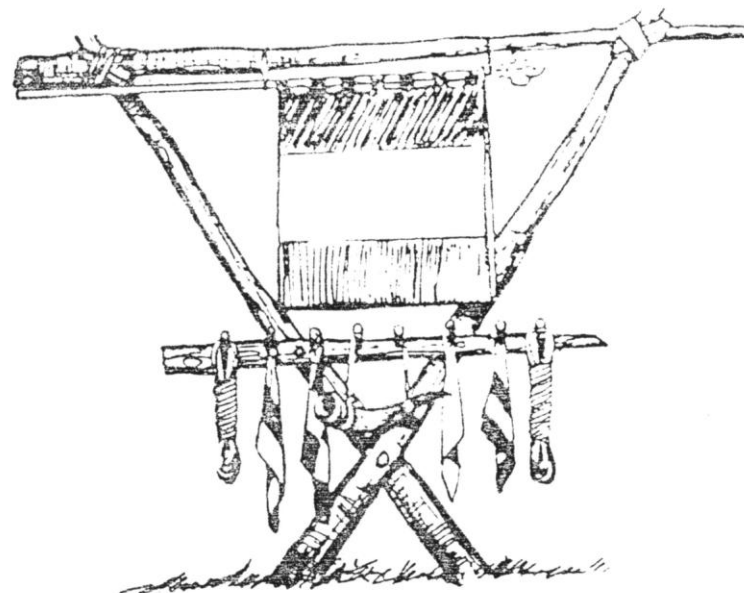

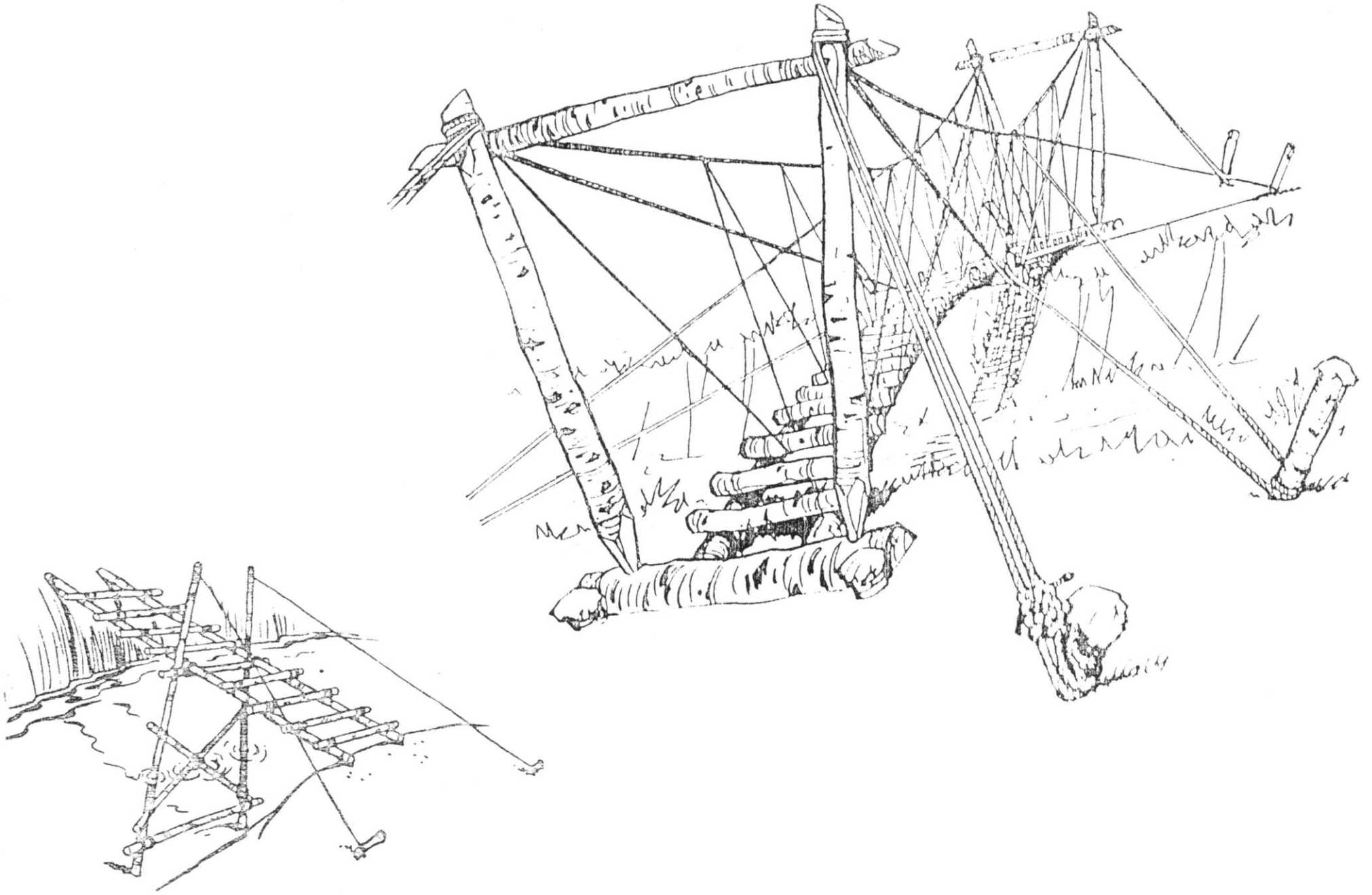

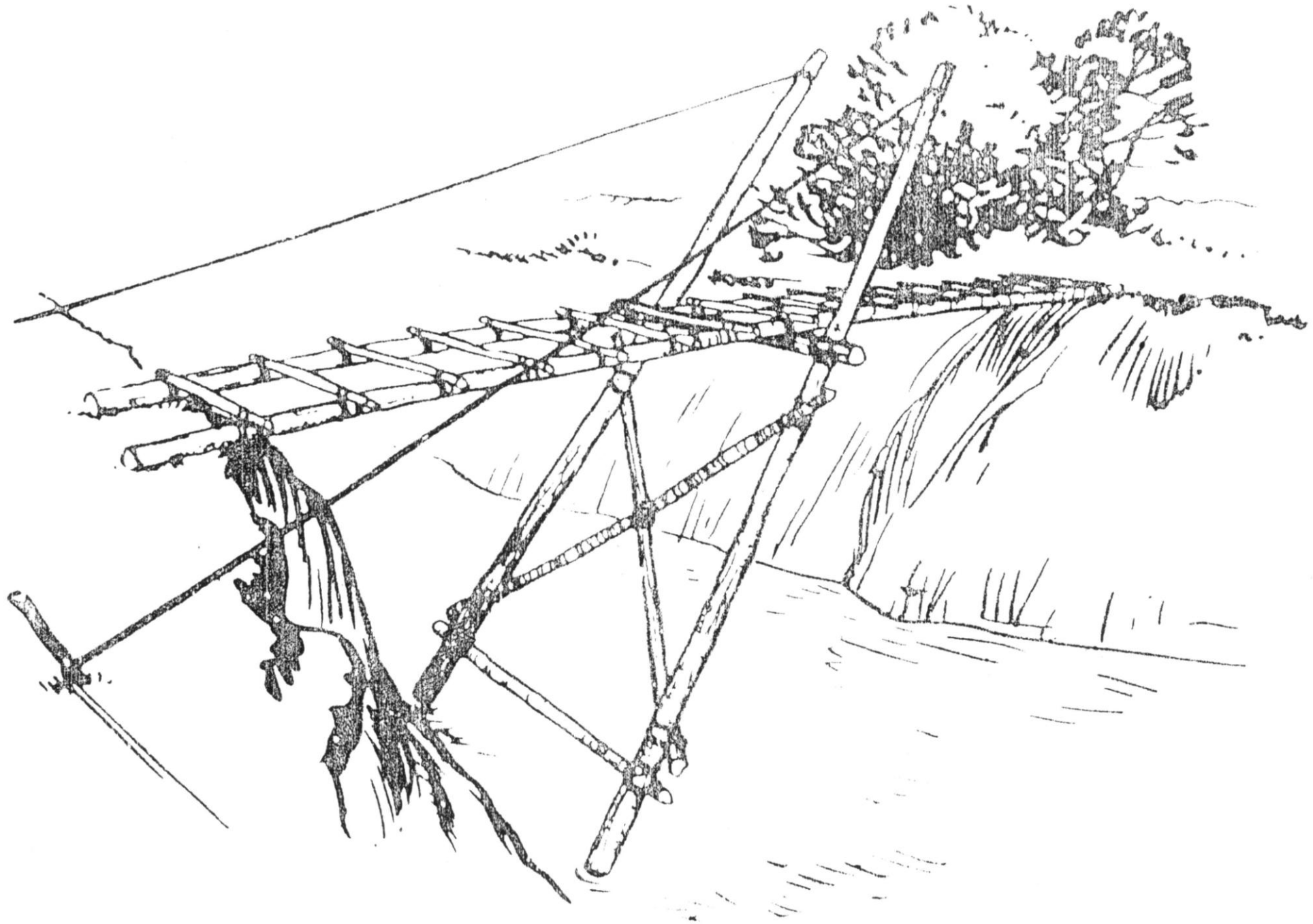



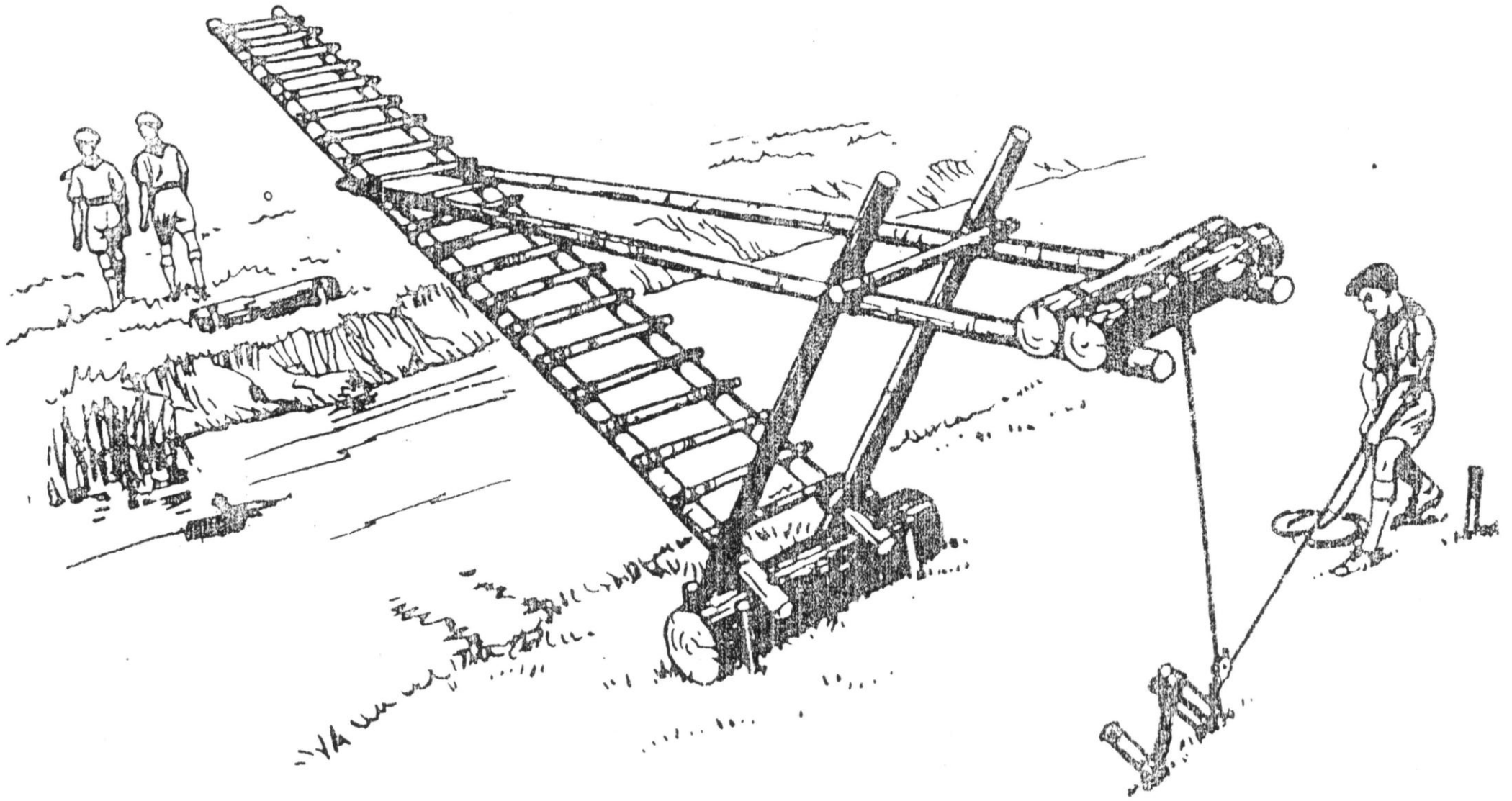

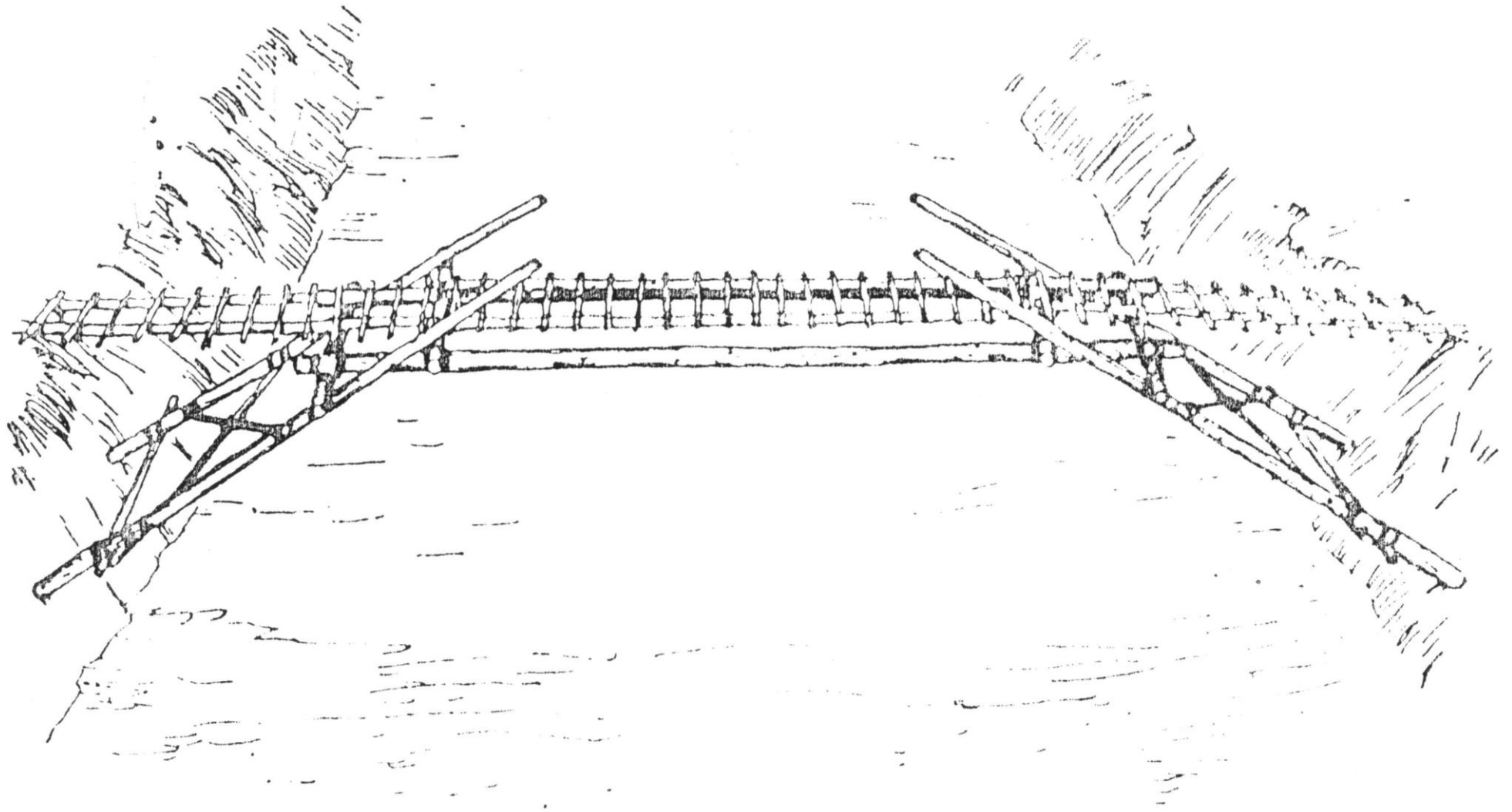

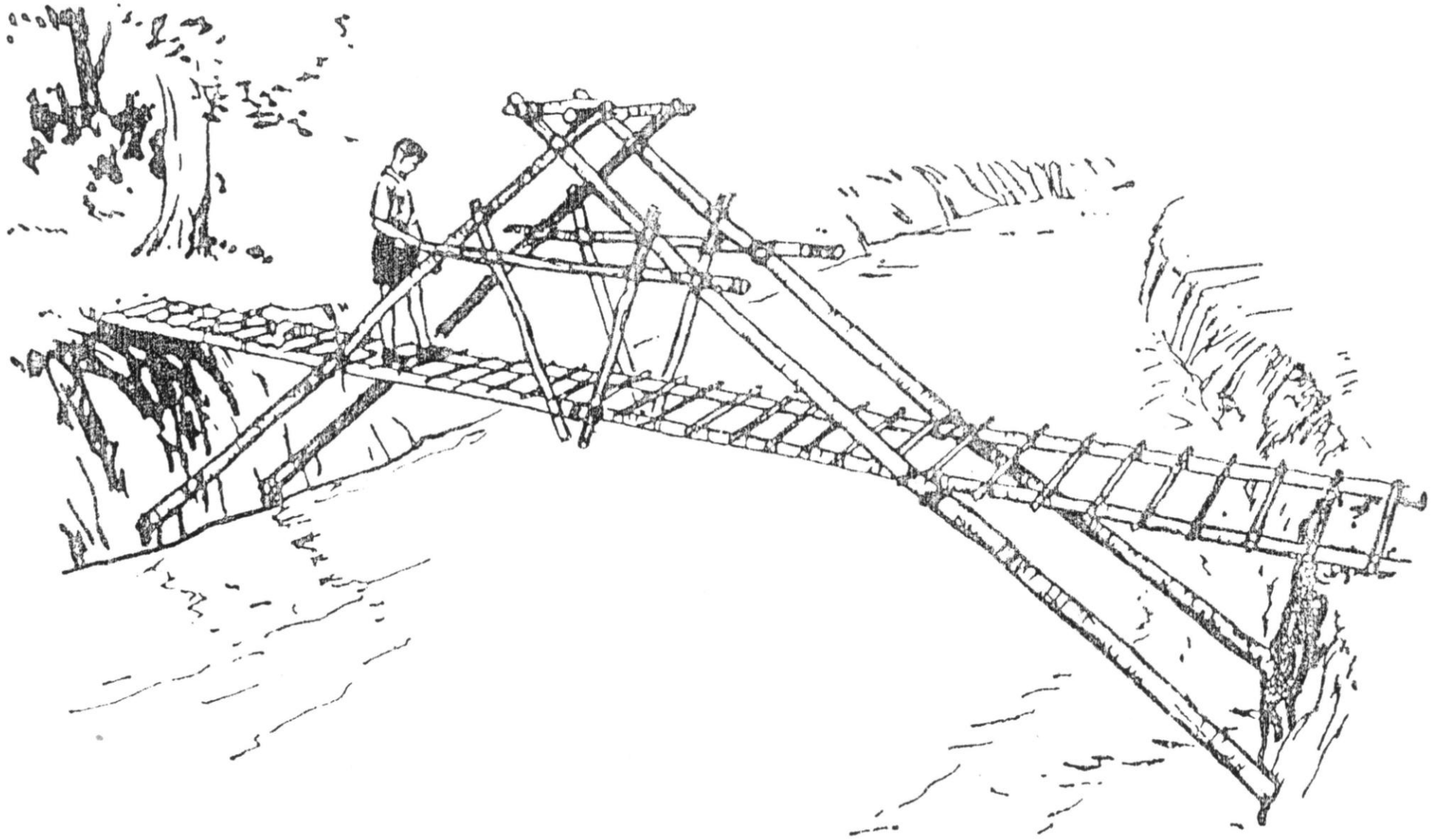



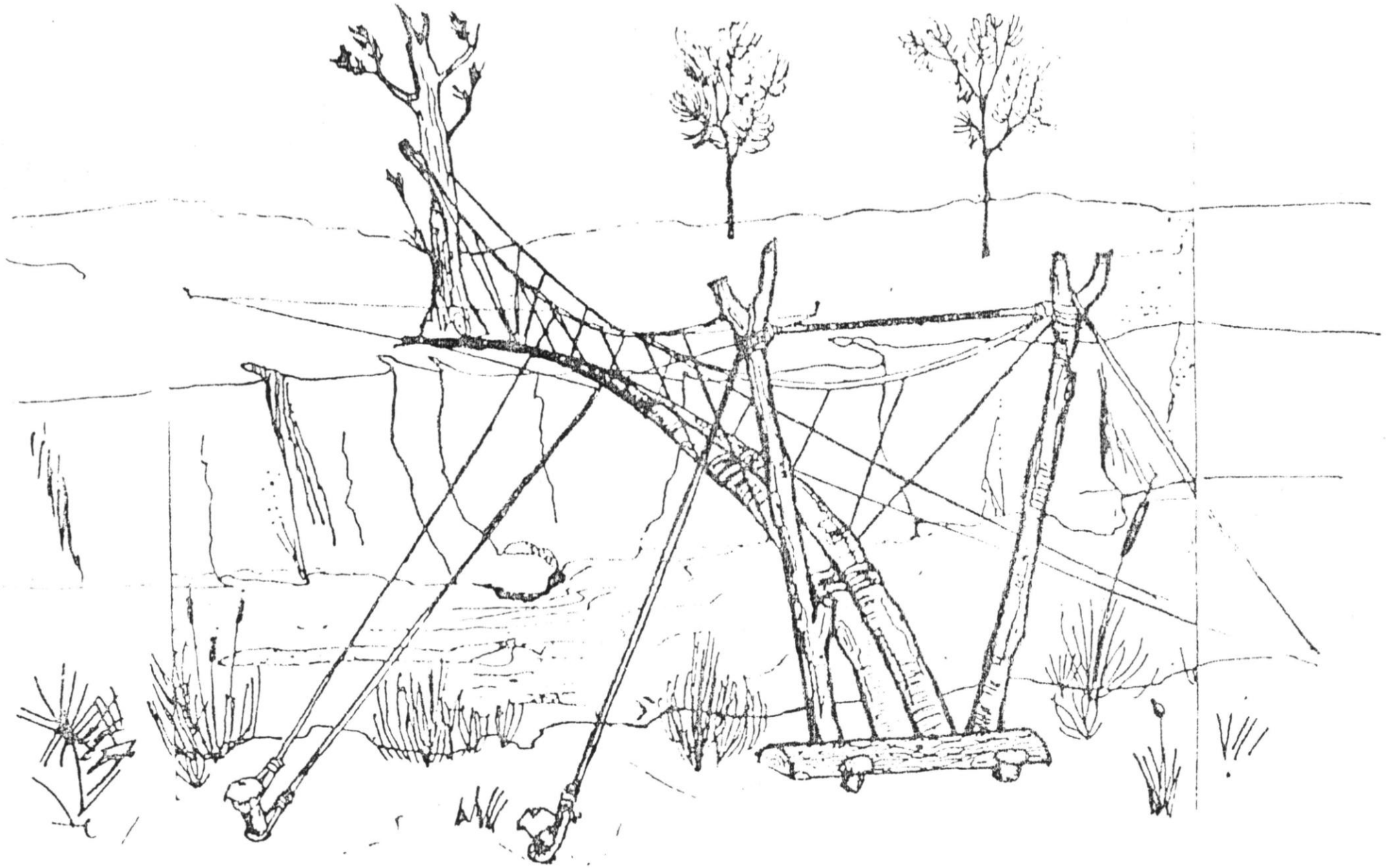

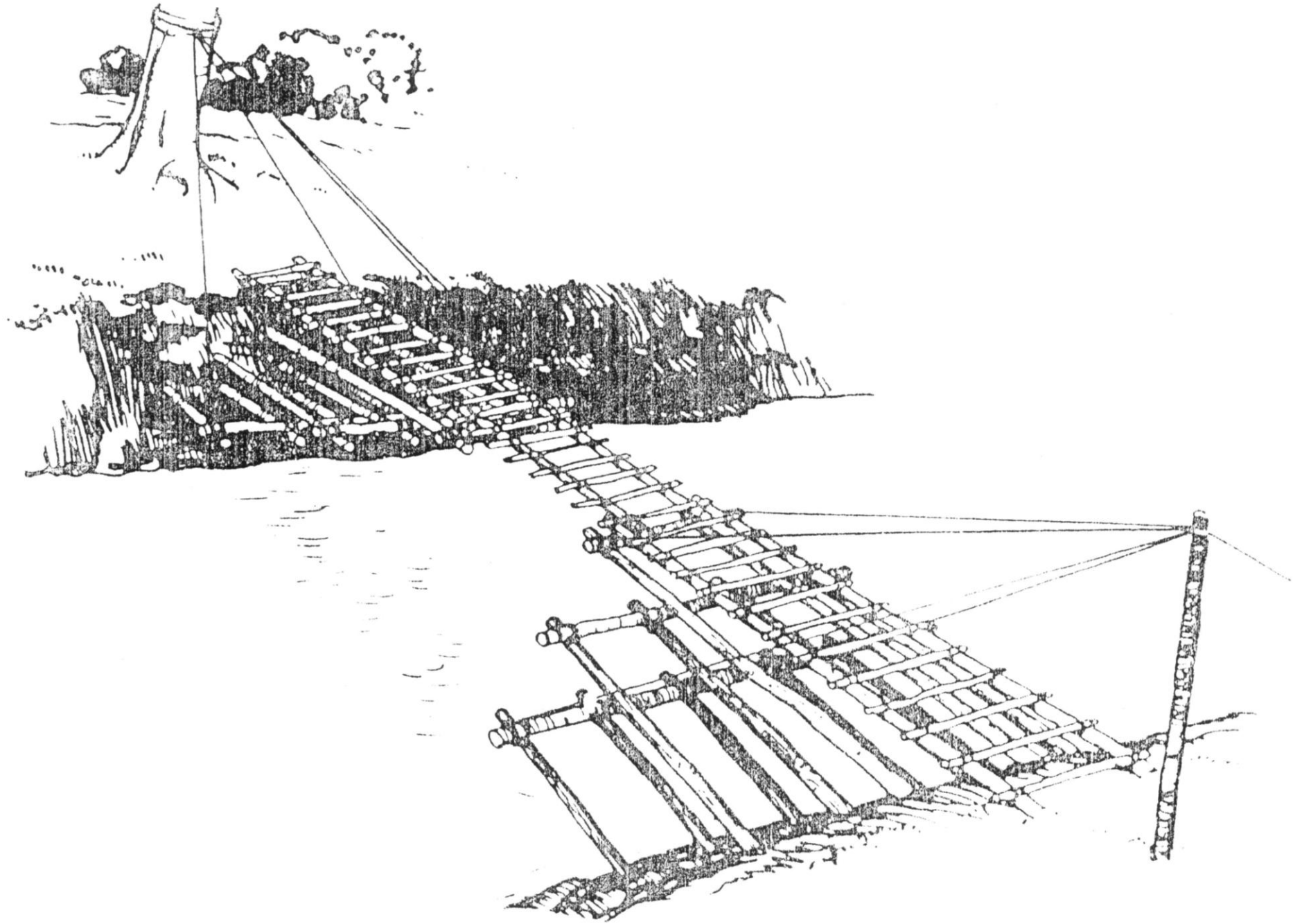

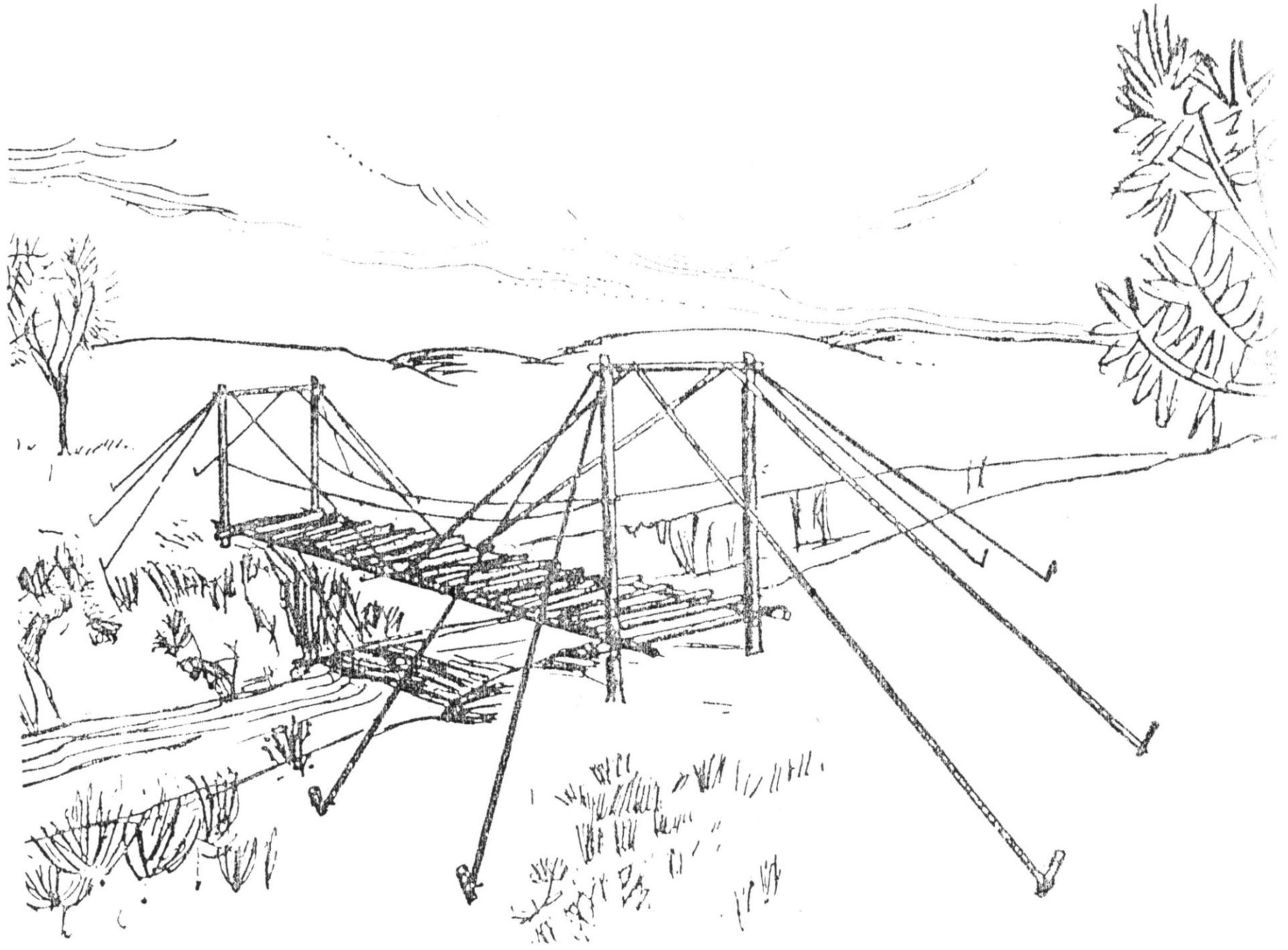



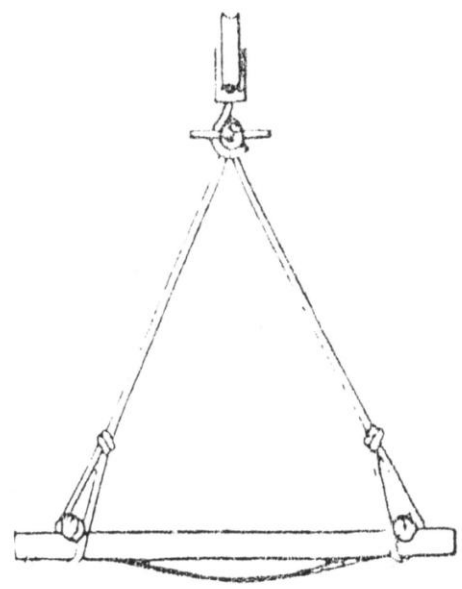
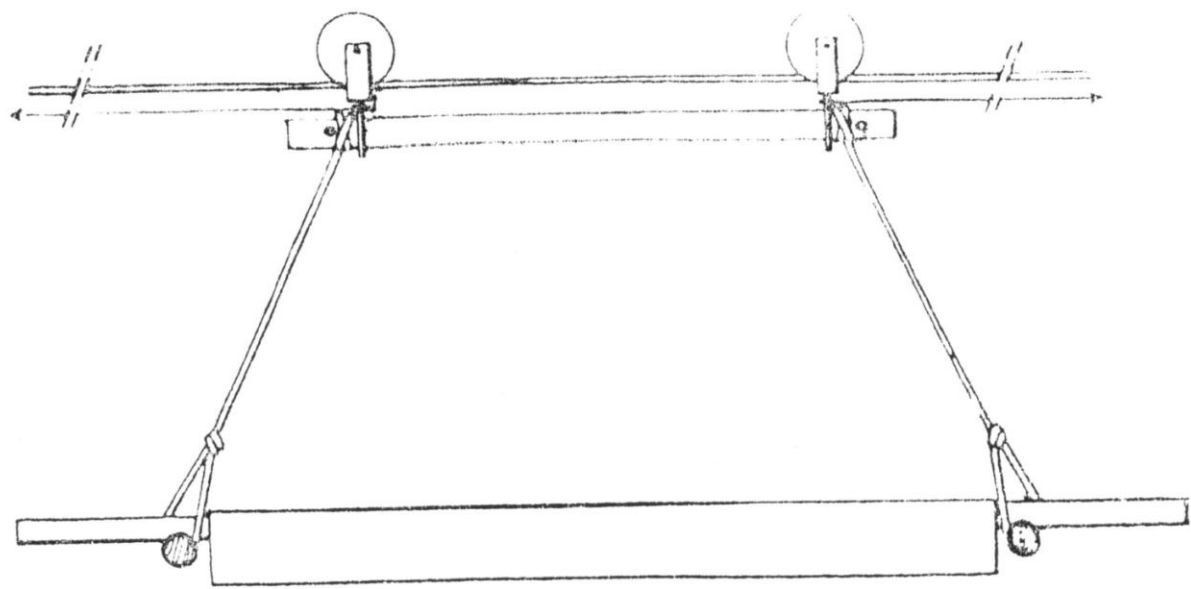
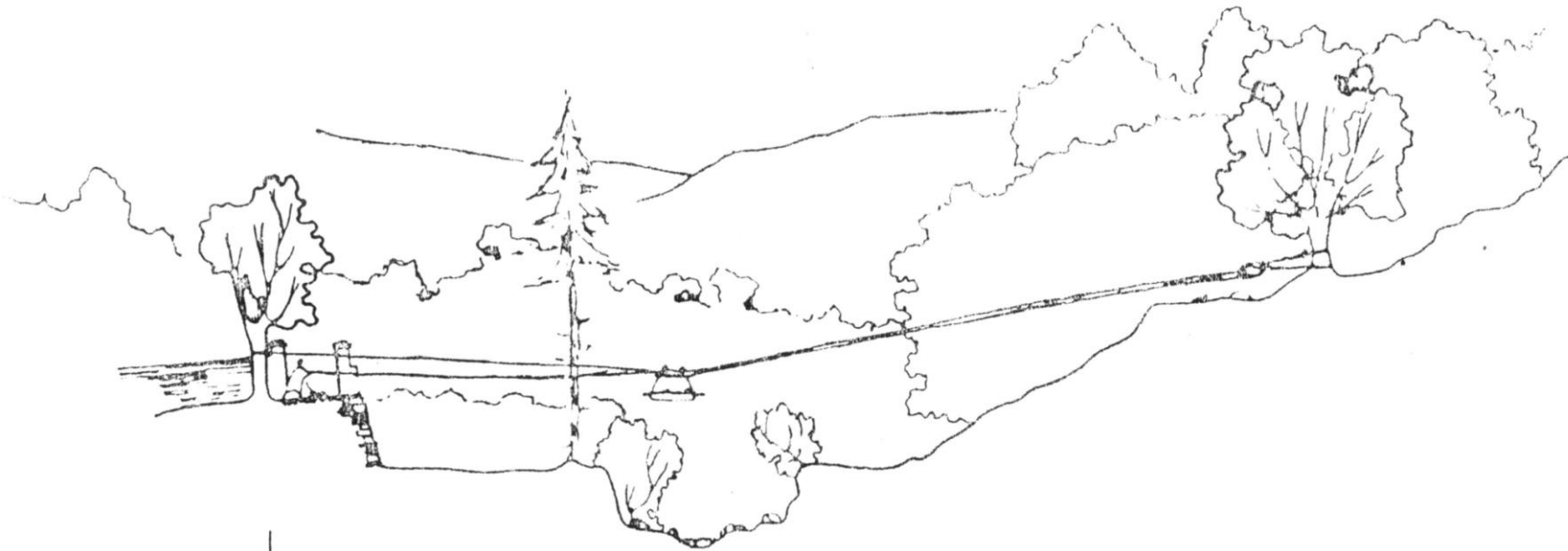

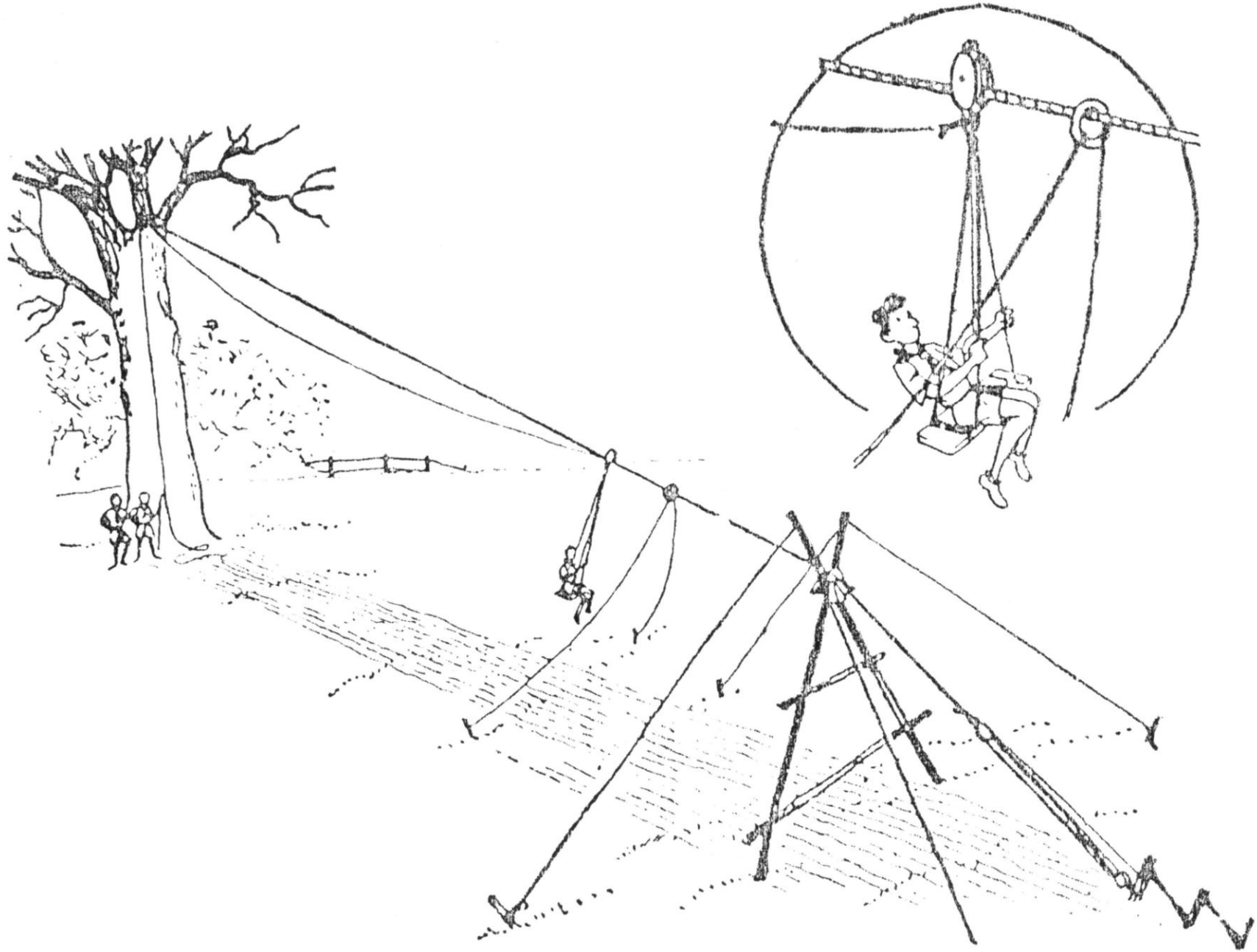

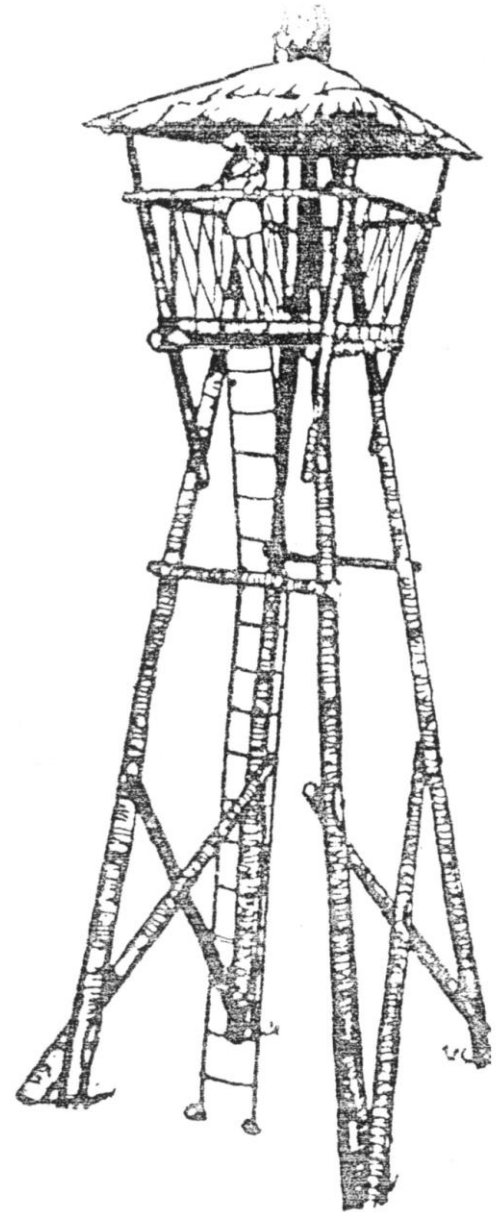
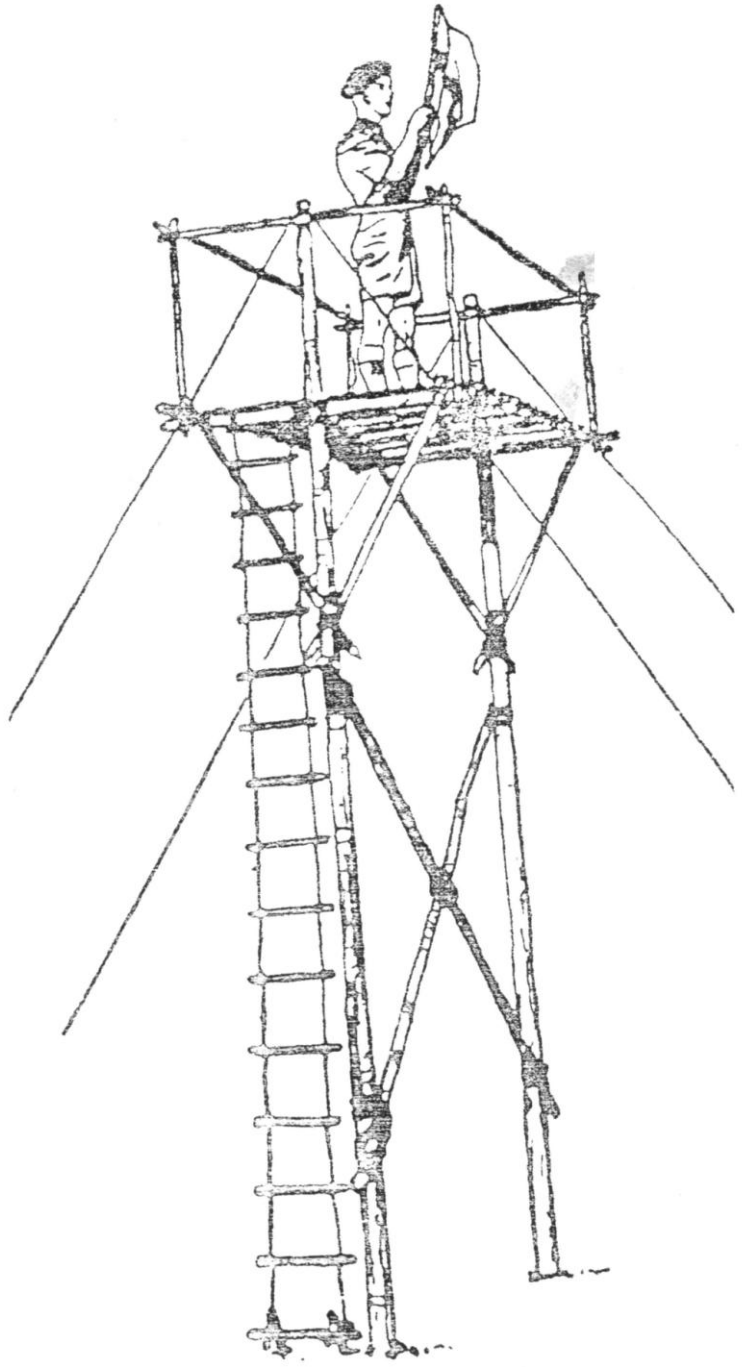



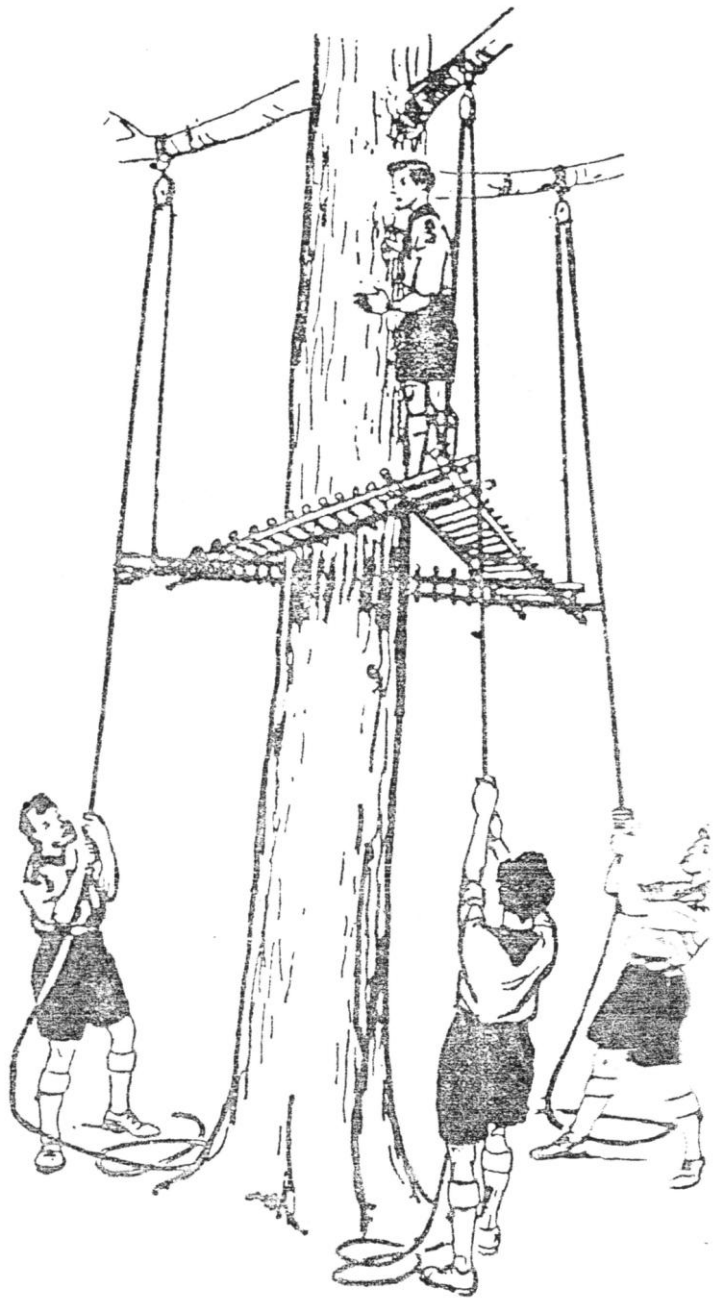
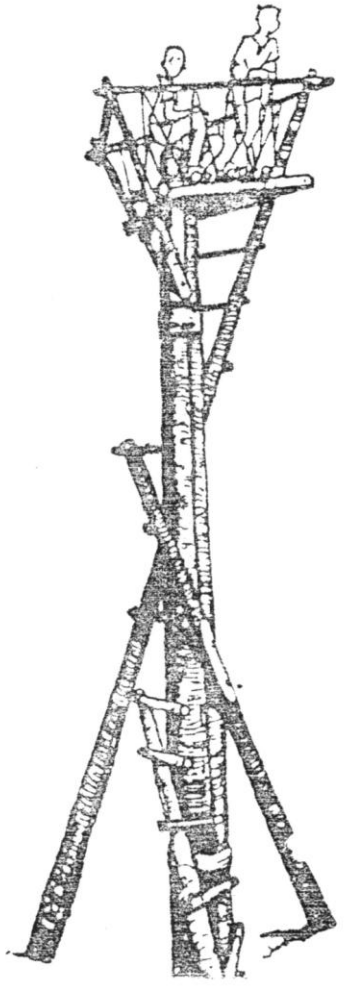
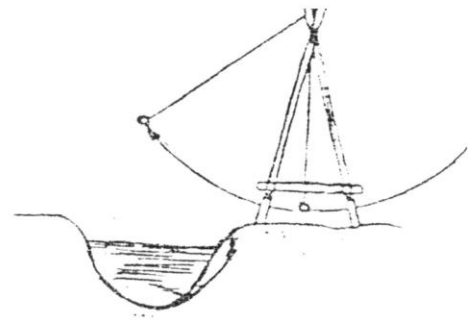
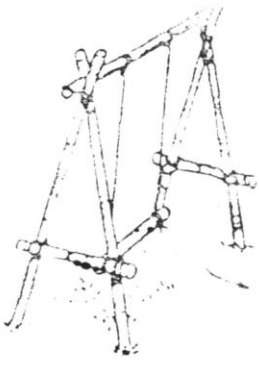

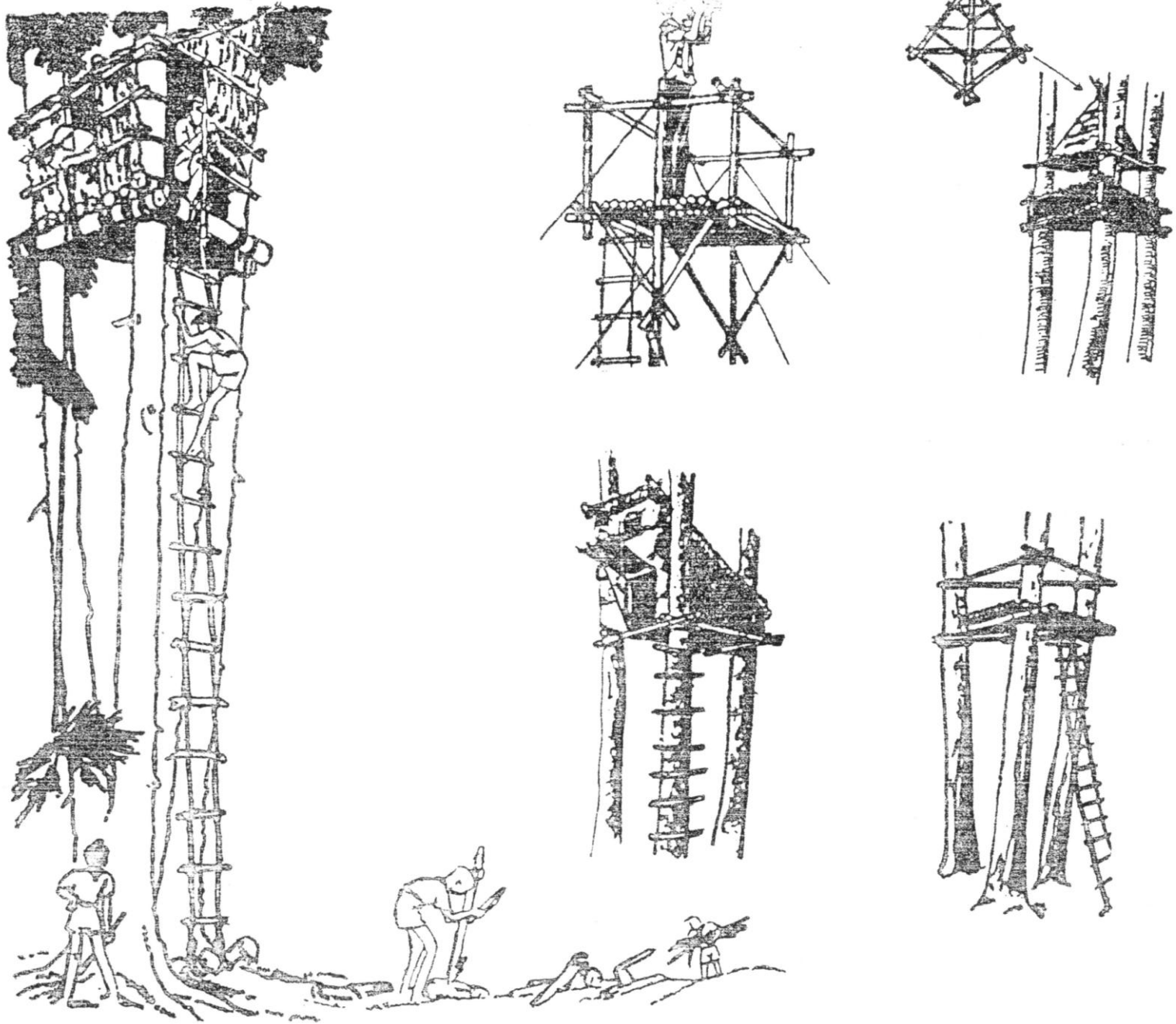

Mesmo no campo,  
lembre-se das medidas e  
posições certas, para garantia  
de conforto, segurança e  
evitar problemas de coluna.

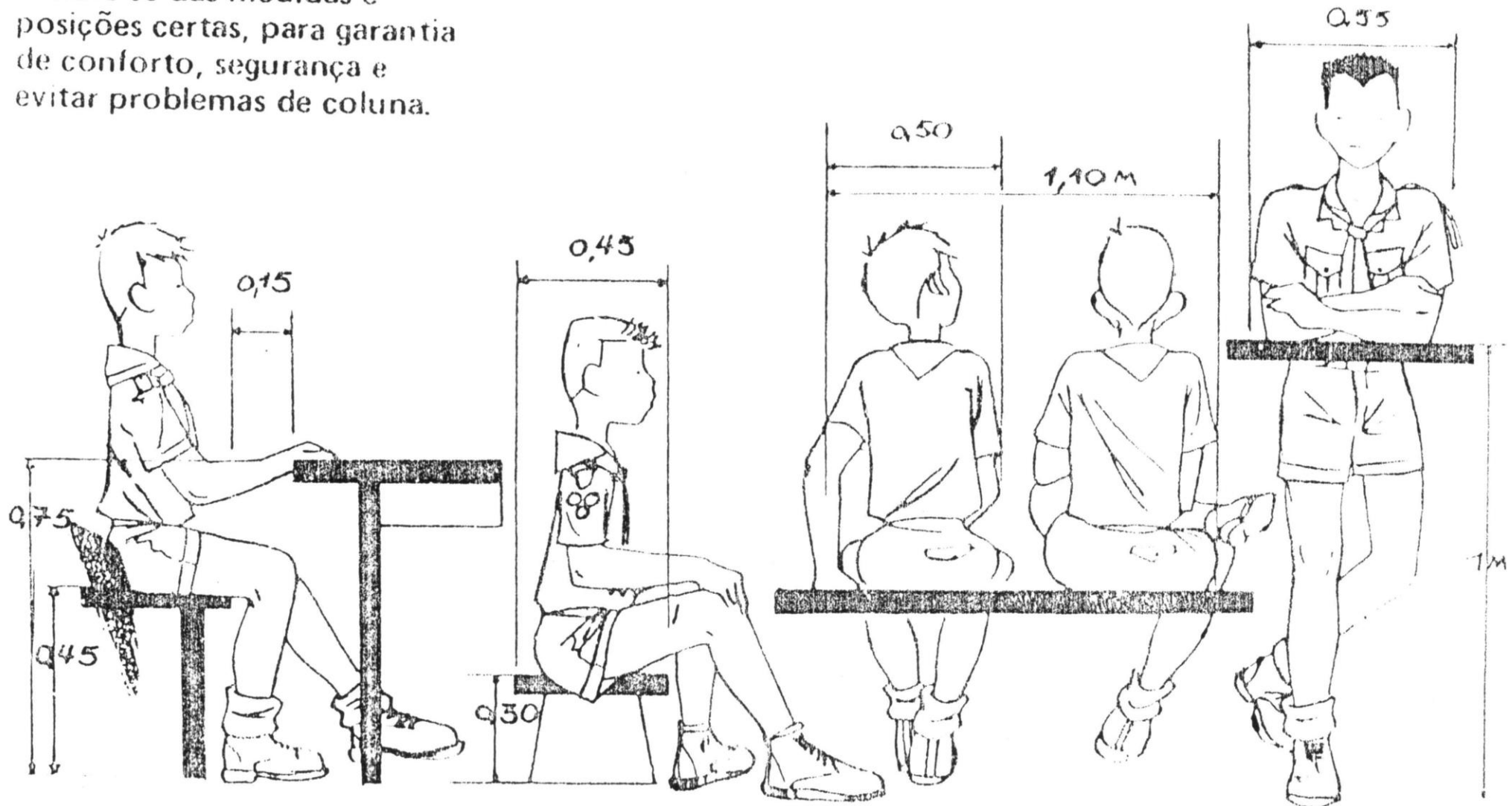



## Esclarecimentos

Para o bem da verdade, esclarecemos que esta apostila foi distribuída em um Curso Básico Escoteiro realizado no Campo Escola do Jaraguá, na década de 1990.

Por ser fruto de cópia da cópia sua qualidade não era muito boa. Procuramos melhorar o que foi possível, mas o fato é que mereceria ser totalmente redesenhada.

Mas, como tem excelentes idéias para atividades de pioneirias, tanto do ramo Escoteiro como do ramo Sênior, reproduzimos no site [www.lisbrasil.com](http://www.lisbrasil.com) para servir de inspiração para boas atividades escoteiras.